

EK-DTC03-OM-001

DECtalk DTC03

Text-to-Speech System

Owner's Manual

**Prepared by Educational Services
of
Digital Equipment Corporation**

1st Edition, December 1985

Copyright © 1985 by Digital Equipment Corporation.
All Rights Reserved.
Printed in U.S.A.

The reproduction of this material, in part or whole, is strictly prohibited. For copy information, contact the Educational Services Department, Digital Equipment Corporation, Maynard, Massachusetts 01754.

The information in this document is subject to change without notice. Digital Equipment Corporation assumes no responsibility for any errors that may appear in this document.

This equipment generates, uses, and may emit radio frequency energy. The equipment has been type tested and found to comply with the limits for a Class A computing device pursuant to Subpart J of Part 15 of FCC Rules, which are designed to provide reasonable protection against such radio frequency interference when operated in a commercial environment. Operation of this equipment in a residential area may cause interference, in which case the user, at his own expense, may be required to take measures to correct the interference.

B25A is a trademark of Western Electric.

BASIC is a trademark of Dartmouth College.

Touch-Tone and AT&T are trademarks of American Telephone and Telegraph Company.

The following are trademarks of Digital Equipment Corporation, Maynard, Massachusetts.

digital

DEC

DECmailer

DECmate

DECnet

DECservice

DECsystem-10

DECSYSTEM-20

DECtalk

DECUS

DECwriter

DIBOL

MASSBUS

PDP

P/OS

Professional

Rainbow

RSTS

RSX

UNIBUS

VAX

VMS

VT

Work Processor

U.S. FCC REQUIREMENTS

The U.S. Federal Communications Commission (FCC) classifies the DECTalk DTC03 as terminal equipment. FCC regulations require that you provide the business office of your local telephone company with the following information before you connect DECTalk to the telephone network.

- The particular lines(s) to which terminal equipment will be connected (by telephone number)
- The make, model number, and FCC registration number (See the label on the back of the equipment.)
- The ringer equivalence for the registered terminal equipment (See the label on the back of the equipment.)
- The type of service needed (if not already installed)

The following list contains that information you need to give the telephone company.

Make: DECTalk

Model: DTC03-AA

FCC registration: A0994Q-71152-AN-E

Ringer equivalence: 0.2B

Type of service: 8 public switched lines in a USOC RJ21X connection arrangement
(See the *DECTalk DTC03 Text-to-Speech System Installation Guide*.)

You must also notify the telephone company when you permanently disconnect terminal equipment from telephone line(s).

You may not connect terminal equipment to a party line or coin-operated telephone equipment.

If terminal equipment damages the telephone network, the telephone company can, after notifying the customer, temporarily discontinue service. However, when prior notice is not practical, the telephone company can temporarily discontinue service immediately. In such cases, the telephone company shall

- promptly notify customers that service has been discontinued
- give customers the opportunity to correct the situation
- inform customers of their right to bring a complaint to the FCC according to Subpart E of Part 68 of FCC Telephone Equipment Rules.

CANADIAN DOC REQUIREMENTS

The Canadian Department of Communications (DOC) label on the DECTalk DTC03 identifies certified equipment. This certification means that the equipment meets certain telecommunications network protective, operational, and safety requirements. The DOC does not guarantee the equipment will operate to the user's satisfaction.

DOC regulations require that you provide the business office of your local telecommunications company with the following information before you install DECTalk.

Make: DECTalk

Model: DTC03-AA

DOC certification: 1921422A

Load number: 5B

Type of service: 8 public switched lines in a CA21A connection arrangement (See the *DECTalk DTC03 Text-to-Speech System Installation Guide*.)

Before you install this equipment, make sure it is permissible to connect it to the local telecommunications company's facilities. You must also install the equipment by using an approved connection method. Be aware that complying with the above conditions may not prevent degradation of service in some situations. Telecommunications company requirements do not allow you to connect their equipment to customer-provided jacks, except where specified by individual telecommunications company tariffs.

Only authorized Canadian maintenance facilities, designated by the supplier, should repair certified equipment. If you repair or alter certified equipment yourself, or if the equipment malfunctions, the telecommunications company has cause to ask you to disconnect the equipment.

You should ensure (for your own protection) that the electrical ground connections for the power utility, telephone lines, and internal metallic water-pipe system, if present, are connected together. This precaution may be particularly important in rural areas.

CAUTION: *Do not try to make such connections yourself. Contact the appropriate electric inspection authority or electrician.*

CONTENTS

INTRODUCTION	xiii
PART 1 GENERAL DESCRIPTION	1
1 GETTING TO KNOW THE SYSTEM	2
1.1 The DECtalk DTC03 System	2
1.2 The DECtalk Module	3
1.2.1 Module Configuration	4
1.2.2 Module Controls	4
1.2.2.1 LEDs	6
1.2.2.2 Pushbuttons	7
1.3 The DECtalk Diagnostic Tests	8
1.3.1 Power-Up Self-Test	8
1.3.2 Routine Self-Test	8
1.4 Operating Mode	9
2 HOW DECtalk WORKS	10
2.1 Converting Text to Speech	10
2.2 DECtalk Software Program	11
PART 2 HOW DECtalk PROGRAMMING WORKS	15
3 COMMUNICATING WITH DECtalk	16
3.1 Programming Guidelines	16
3.1.1 Types of Data	18
3.2 Using Escape Sequences and Control Characters	18
3.2.1 Escape Sequences	18
3.2.2 Escape Sequence Format	20
3.2.3 Special Characters	22
3.2.4 Effect of the Backspace (BS) Character	23

CONTENTS

3.3	DECtalk-Computer Communication	23
3.3.1	DECtalk Setups	26
3.3.2	Program Control	26
3.3.3	Data Synchronization	27
4	CHARACTER ENCODING AND SETUP ESCAPE SEQUENCES	29
4.1	Selecting ASCII Character Sets	29
4.2	Coding Standards	31
4.3	Code Tables	31
4.3.1	7-Bit ASCII Code Table	32
4.3.2	8-Bit Code Table	34
4.4	Character Sets	35
4.4.1	Designating Alternate Graphic Sets	38
4.4.2	Invoking Graphic Sets into GL and GR	42
4.4.3	Character Processing	42
4.5	Control Functions	43
4.5.1	Escape Sequences	43
4.5.2	Control Sequences	44
4.5.3	Device Control Strings	45
4.6	Working with 7-Bit and 8-Bit Environments	45
4.6.1	7-Bit and 8-Bit C1 Controls	45
4.6.2	Mode Selection (DT_MODE)	46
5	MAINTENANCE AND TEST COMMANDS	49
5.1	Conformance Level Request (DECSCL)	49
5.2	Device Attribute Requests	50
5.2.1	Device Attribute Request (DA Primary)	50
5.2.2	Device Attribute Request (DA Secondary)	50
5.3	Device Test and Status	51
5.3.1	DECtalk Power-Up Status	51
5.3.2	Device Self-Tests (DECTST)	52
5.3.3	Device Status Request (DSR) (Brief Report)	53
5.3.4	Device Status Request (DSR) (Extended Report)	54
5.3.5	Reset to Initial State (RIS)	55
5.3.6	Soft Terminal Rest (DECSTR)	56
5.3.7	NVR Control (DECNVR)	56

6	TELEPHONE COMMUNICATIONS	57
6.1	Telephone Management (DT_PHONE)	58
6.1.1	PH_ANSWER	61
6.1.2	PH_HANGUP	61
6.1.3	PH_KEYPAD	62
6.1.4	PH_NOKEYPAD	62
6.1.5	PH_STOPPAD	62
6.1.6	PH_TIMEOUT	63
6.1.7	PH_TONE_DIAL and PH_PULSE_DIAL	63
6.1.8	PH_WINK	65
6.1.9	PH_NOWINK	65
6.1.10	Examples of Telephone Communication Sessions	65
6.2	Keypad Mask (DT_MASK)	70
PART 3	DECTalk PHONEMICS AND VOICES	73
7	DECTalk PHONEMIC INPUT	74
7.1	Phonemic Transcription	74
7.2	Pronunciation Errors	74
7.3	Introduction to Phonemic Theory	77
7.4	Phonemes	78
7.5	Vowel and Consonant Phonemes	79
7.5.1	Phonemic Correction the Easy Way	82
7.5.2	Automatic Phonemic Substitution for a Mispronounced Word	82
7.5.3	Vowels	83
7.5.4	Vowel Allophones	83
7.5.4.1	Allophones for R-Colored Vowels	84
7.5.4.2	Schwa Allophone	84
7.5.4.3	Syllabic Consonants	84
7.5.5	Consonants	85
7.5.6	Consonant Allophones	85
7.5.6.1	Dental Flap	85
7.5.6.2	Glottal-T	85
7.5.6.3	Postvocalic-R	85
7.5.6.4	Postvocalic-L	86
7.5.6.5	Glottal Stop	86
7.5.6.6	Controlling Allophone Selection	86
7.5.7	Silence Phoneme []	86

CONTENTS

7.6	Stress and Syntactic Symbols	86
7.6.1	Primary Stress [']	88
7.6.2	Secondary Stress []	89
7.6.3	Emphatic Stress ["]	90
7.6.4	Unstressed Syllables	91
7.6.5	Pitch Control [/], [\], [/ \]	92
7.6.6	Word Boundary	92
7.6.7	Syllable Boundary [-]	92
7.6.8	Morpheme Boundary [*]	93
7.6.9	Compound Noun [#]	93
7.6.10	Beginning of Verb Phrase []	94
7.6.11	Clause Boundary [,]	95
7.6.12	Period [.]	96
7.6.13	Question Mark [?]	96
7.6.14	Exclamation Point [!]	97
7.6.15	New Paragraph [+]	97
7.7	Direct Control of Duration and Pitch	98
7.7.1	Duration and Pitch [< >]	98
7.7.2	Singing	100
7.8	Selected Readings	102
8	VOICE COMMANDS AND THE USER DICTIONARY	103
8.1	Speech Control	103
8.2	Speech Timeout	104
8.3	English Text	104
8.4	Speak Phonemic Text (DT_PHOTEXT)	105
8.5	Stop Speaking (DT_STOP)	105
8.6	Data Synchronization (DT_SYNC)	106
8.7	Enable or Disable Speaking (DT_SPEAK)	106
8.8	Indexing	107
8.8.1	Index Text (DT_INDEX)	107
8.8.2	Index Reply (DT_INDEX_REPLY)	108
8.8.3	Index Query (DT_INDEX_QUERY)	108
8.9	Load Dictionary (DT_DICT)	110
8.10	Input Logging (DT_LOG)	111
9	MODIFYING THE VOICES	112
9.1	Voice Characteristics	112
9.2	Speaking Rate [:ra _]	115
9.3	Pause Durations [:pp _] and [:cp _]	116

9.4	Selecting a Standard Voice [:n__]	117
9.5	Designing a Voice with Speaker-Definition Parameters [:dv__]	118
9.5.1	Changing Sex and Head Size	122
9.5.1.1	Sex, sx	122
9.5.1.2	Head Size, hs	123
9.5.1.3	Higher Formants, f4, f5, b4, and b5	124
9.5.2	Changing Voice Quality	125
9.5.2.1	Breathiness, br	125
9.5.2.2	Lax Breathiness, lx	125
9.5.2.3	Smoothness, sm	126
9.5.2.4	Richness, ri	126
9.5.2.5	Nopen Fixed, nf	127
9.5.2.6	Laryngealization, la	127
9.5.3	Changing the Pitch and Intonation of the Voice	128
9.5.3.1	Baseline Fall, bf	128
9.5.3.2	Hat Rise, hr	129
9.5.3.3	Stress Rise, sr	130
9.5.3.4	Assertiveness, as	130
9.5.3.5	Quickness, qu	130
9.5.3.6	Average Pitch, ap, and Pitch Range, pr	130
9.5.4	Changing Relative Gains and Avoiding Overloads	132
9.5.4.1	Loudness, lo	132
9.5.4.2	Sound Source Gains, gv, gh, and gf	133
9.5.4.3	Cascade Vocal Tract Gains, g1, g2, g3, and g4	133
9.5.5	The [save] Parameter and [:nv] Voice	134
9.5.6	Summary on Speaker-Definition Parameters	134
9.6	Voice Command Syntax	134
10	HOW TO GET THE MOST OUT OF DECTalk	136
10.1	Developing Your Application	136
10.1.1	Names, Part Numbers, and Alphanumeric Text	138
10.1.2	Direct Numeric Encoding	138
10.1.3	Two-Character Encoding	138
10.1.4	Ending Commands and Data	139
10.1.5	Application Development Tips	139
10.2	Developing an Advanced Application	140
10.3	Optimizing the Quality of Spoken Text	142
10.4	Common Errors	144

CONTENTS

APPENDIX A	DECTalk ESCAPE SEQUENCES, STATUS REPLIES, AND PARAMETERS	146
APPENDIX B	CONFIGURING THE DECTalk MODULE	154
B.1	Setting the Configuration Switches	154
B.1.1	Line Speed	156
B.1.2	Data Format	156
B.1.3	Keypad Mask	156
B.1.4	Busyout	157
B.2	Testing the Module	157
APPENDIX C	ABBREVIATIONS AND ACRONYMS	159
C.1	Text Processing Rules	159
C.2	Number Processing	161
C.2.1	Part Numbers	161
C.2.2	Cardinal Numbers	163
C.2.3	Ordinal Numbers	166
C.2.4	Fractions	166
C.2.5	Money	166
C.2.6	Dates	167
C.2.7	Time of Day	167
C.3	Abbreviations	167
C.3.1	Abbreviations Processed by DECTalk	167
C.3.2	Abbreviations in the Built-In Dictionary	168
C.4	Word Spellout Strategies	170
C.4.1	Word Spellout Tests	170
C.4.2	Multinational Characters	172
APPENDIX D	WORDS WITH TWO PRONUNCIATIONS	173
APPENDIX E	DECTalk/DICTIONARY PHONEMIC CORRESPONDENCE	177
E.1	Webster's Ninth New Collegiate Dictionary	180
E.2	American Heritage Dictionary	181
APPENDIX F	TEXT TUNING EXAMPLE	182
APPENDIX G	BASIC PROGRAM EXAMPLE	185

APPENDIX H	SERVICE AND DOCUMENTATION	191
H.1	Digital's Services	191
H.1.1	DECservice	191
H.1.2	Basic Service	192
H.1.3	Per Call Service	192
H.1.4	Carry-In Service	192
H.1.5	DECmailer Service	193
H.1.6	Digital Field Service Information Numbers	193
H.2	Related Documents	194
H.3	Ordering Information	195
INDEX		196

FIGURES

1-1	DECTalk DTC03 System Configuration	2
1-2	DECTalk DTC03 Communications Cabling	3
1-3	Accessing the DECTalk Modules	4
1-4	Module LEDs and Pushbuttons	5
2-1	Text-to-Speech Conversion	11
3-1	DECTalk-to-Host Communications	17
3-2	Typical Escape Sequence Format	19
3-3	Escape Sequence Representations	20
3-4	DECTalk and Host Computer Programming Interaction	25
3-5	Synchronizing DECTalk and Host Communications	28
4-1	Mapping 7-Bit and 8-Bit Tables	30
4-2	7-Bit ASCII Code Table	32
4-3	Data Word Representation	33
4-4	8-Bit Code Table	34
4-5	ASCII_G Character Set	36
4-6	DEC Supplemental Character Set	37
4-7	U.K. National Character Set	38
4-8	Loading 8-Bit Characters	40
4-9	Loading 7-Bit Characters	41
6-1	Phone Call Session with User Disconnect	66
6-2	Successful Dialout Session	67
6-3	Busyout Session	68
6-4	No Answer Session	69

CONTENTS

7-1	Phonemes Classified by Their Position in the Mouth Cavity	79
8-1	Using the DT_SYNC and DT_INDEX_QUERY to Coordinate DECtalk Communications	109
9-1	The DECtalk Voices	113
B-1	DIP Switchpack Settings	155
B-2	DECtalk Module Controls	158

TABLES

3-1	Special Characters and Host Communications	22
4-1	Selecting 7-Bit or 8-Bit Mode	30
4-2	Invoking G-Sets	39
4-3	Designating Character Sets	42
4-4	DT_MODE Parameters	47
5-1	Restoring DECtalk Default Operating Features	51
5-2	DECtalk Actions Performed at Resets	52
5-3	Self-Test Parameters	53
5-4	DSR (Extended Report) Error Codes	55
6-1	DT_PHONE Parameters	59
6-2	Phone Status Reply Codes	60
6-3	DT_MASK Parameters	70
7-1	English Vowel Phonemes	80
7-2	English Consonant Phonemes and Allophones	81
7-3	Stress and Syntactic Symbols	87
7-4	Tone Values	101
9-1	Voice Modification Commands	114
9-2	New Voice Commands	117
9-3	Speaker Definition [:dv_] Parameter Range	119
9-4	Speaker Definition for All DECtalk Voices	121
A-1	Escape Commands	147
A-2	DECtalk Status Replies	150
A-3	Conformance Level and C1 Format Setting Parameters	153
A-4	Dialing Characters	153
C-1	Numeric Abbreviations Recognized by DECtalk	165
C-2	Abbreviations Recognized by DECtalk	168
D-1	Words with Alternate Pronunciations	174
E-1	DECtalk and Dictionary Phonemic Alphabets	178

INTRODUCTION

ABOUT THE DECtalk DTC03

Video terminals display information from a computer on a screen. Printers display the same information on paper. These devices allow you to communicate with computers through the sense of sight.

The DECtalk DTC03 is another device that allows you to communicate with computers. However, this device speaks information in English. It allows you to communicate through the sense of hearing.

The DECtalk DTC03 is a text-to-speech system. It converts computer text to computer speech. This system can provide any computer with a human-sounding voice.

ABOUT THIS MANUAL

This manual provides information about the DECtalk DTC03 system for general users and programmers. To make reading easier, this manual uses the term *DECtalk* when describing system performance.

The manual is divided into three parts. Part 1 provides a general description of the DECtalk DTC03 and how it works. Part 2 describes how to use and program the DECtalk DTC03 to work with a host computer. Part 2 also explains the escape sequences you can use with the DECtalk DTC03. Part 3 explains the DECtalk DTC03 phonemics and voices.

The appendices at the back of the manual provide additional information to help you use and program the DECtalk DTC03.

INTRODUCTION

Part 1 General Description

- Chapter 1, "Getting to Know the System," describes the DECtalk DTC03 system and its modules. This chapter also provides general operating and testing information.
- Chapter 2, "How DECtalk Works," describes the DECtalk speech generating system and gives an overview of how the system operates.

Part 2 How DECtalk Programming Works

- Chapter 3, "Communicating with DECtalk," describes how the DECtalk DTC03 communicates with a host computer through a computer application program. This chapter also provides some guidelines for writing applications.
- Chapter 4, "Character Encoding and Setup Escape Sequences," describes the ASCII character sets and some escape sequences that initialize and control the DECtalk environment.
- Chapter 5, "Maintenance and Test Commands," describes the maintenance and test commands used to identify and test DECtalk.
- Chapter 6, "Telephone Communications," describes how the DECtalk DTC03 works when connected to a telephone network.

Part 3 DECTalk Phonemics and Voices

- Chapter 7, "DECTalk Phonemic Input," describes the sound system of English. This chapter shows how to correct DECTalk's pronunciation to produce natural, human-sounding speech.
- Chapter 8, "Voice Commands and the User Dictionary," describes how to use voice commands from the host computer to send phonemic text to DECTalk. This chapter also describes how to load the user dictionary.
- Chapter 9, "Modifying the Voices," shows how to change the voices provided by DECTalk and how to create a new voice. This chapter includes commands to change the speaking rate.
- Chapter 10, "How to Get the Most Out of DECTalk," describes some techniques for writing applications. This chapter also gives programming and operating hints to optimize DECTalk performance.

Appendices

- The appendices summarize DECTalk's escape sequences and parameters, phonemic alphabet, abbreviations, acronyms, and homographs. The appendices also contain a text tuning example, a BASIC program sample, a configuration procedure, a description of Digital Equipment Corporation's services, and a list of DECTalk documents.

PART 1

GENERAL DESCRIPTION

Chapter 1	Getting to Know the System	2
Chapter 2	How DECtalk Works	10

1 GETTING TO KNOW THE SYSTEM

This chapter provides a general description of the DECTalk DTC03 system. It covers the DECTalk module and its configuration, controls, diagnostic tests, and operating mode.

1.1 THE DECTalk DTC03 SYSTEM

The DECTalk DTC03 system, or DTC03-AA, is intended for use in voice communication systems that have multiple users. Such high-volume systems require a multiline configuration, as shown with the DTC03-AA in Figure 1-1. The host computer sends text to the DTC03-AA, and the resulting speech can be heard through a telephone.

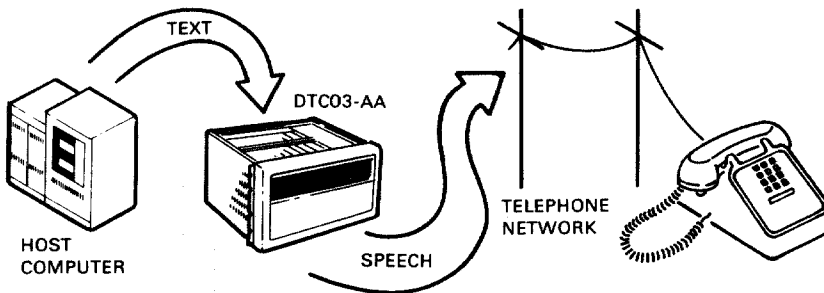

MA-1264-85

Figure 1-1 DECTalk DTC03 System Configuration

The DTC03-AA is a set of text-to-speech converters. These converters are single-board modules that mount in a rack enclosure. The enclosure contains eight modules and fits into any standard computer cabinet that is 48.26 centimeters (19 inches) wide.

1.2 THE DECtalk MODULE

The DECtalk module, or C5005, is a unit for converting text to speech. Each of the eight modules in the DTC03-AA supports one telephone line. The modules connect to one or more host computers through EIA RS232-C serial lines. For example, Figure 1-2 shows the cabling from the rack enclosure to two host computers and the telephone network.

The modules receive power through a common power supply in the rack enclosure. The power switch on the rear panel of the enclosure powers up all eight modules (Figure 1-2).

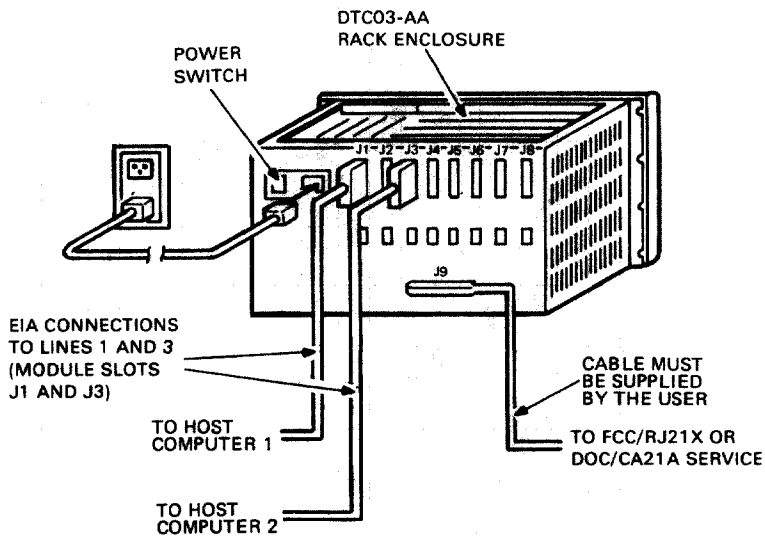

Figure 1-2 DECtalk DTC03 Communications Cabling

1.2.1 Module Configuration

The DECTalk modules are configured at system installation by Field Service of Digital Equipment Corporation. Module configuration is done according to the communication requirements of the user.

Each module is individually configured through an 8-position DIP switchpack. At power-up, the module controller consults the DIP switchpack to determine the required baud rate and operating characteristics.

NOTE: Switch functions and settings are described in Appendix B of this manual.

1.2.2 Module Controls

To operate and test the DECTalk DTC03 system, you need to use the controls on the modules inside the rack enclosure. You can reach the modules by opening the front door of the enclosure (Figure 1-3).

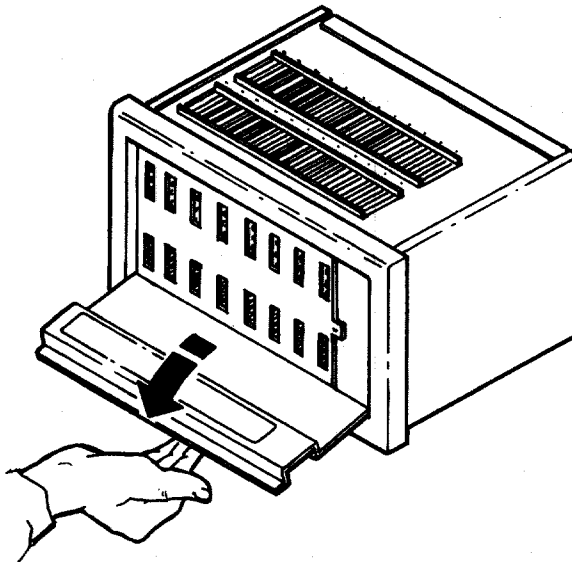

MA-0358-85

Figure 1-3 Accessing the DECTalk Modules

Each module has four light emitting diodes (LEDs) and six pushbuttons on the front edge (Figure 1-4). These controls allow you to work with individual modules in the system.

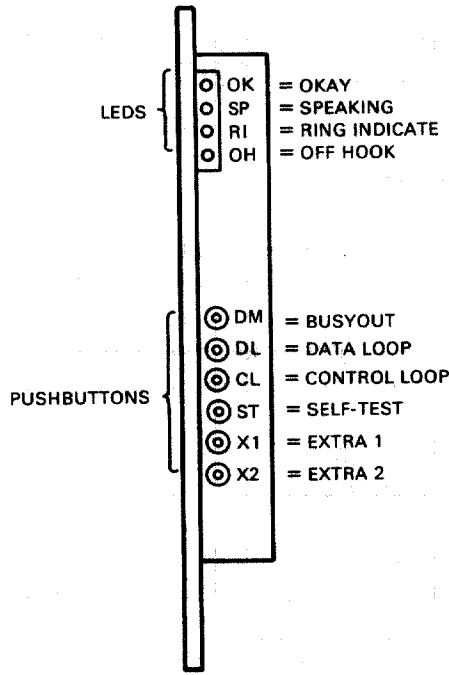

MA-0354-86

Figure 1-4 Module LEDs and Pushbuttons

1.2.2.1 LEDs – When the module first powers up, all four LEDs light for about 0.5 seconds. This display allows you to detect malfunction in the LEDs themselves. Then all four LEDs turn off while the module runs the power-up self-test.

At the end of the self-test, the LEDs display two types of information: status or diagnostic.

The following list describes the status displays. When the LEDs display status information, they light continuously. Each LED represents a single condition. Most display combinations are valid.

LED	Function
OK	This LED lights when the module successfully passes the self-test and is ready for operation.
SP	This LED lights when the module is speaking. During tone dialing, this LED flashes. Otherwise, it is off.
RI	This LED lights when the telephone is ringing. Otherwise, this LED is always off.
OH	This LED lights when the telephone is off the hook. This LED flashes during pulse dialing. Otherwise, it is off.

To display diagnostic information, these LEDs flash an error code or they all stay off. A diagnostic display indicates module failure. If the LEDs flash or stay off, call Digital's Field Service for help. See Appendix H for a list of telephone numbers.

1.2.2.2 Pushbuttons – When pressed, the pushbuttons activate functions such as diagnostic and loopback tests for checking the operation of the module. When released, the pushbuttons deactivate the functions.

Pushbutton	Function
DM	This pushbutton causes the module to pass over (or “busy out”) the telephone line. This function can be enabled at installation if busyout is permitted by the local communication regulations.

WARNING: *In many areas, the busyout capability is prohibited. Check with the local telephone company and call Digital's Field Service to determine whether busyout can be enabled in your system.*

DL	This pushbutton loops back the transmit data through the host I/O port.
CL	This pushbutton loops back modem control commands through the host I/O port.
ST	This pushbutton activates the diagnostic tests, which include the power-up self-test plus the external data and control loopback tests.
X1	This pushbutton is reserved for use with an optional module.
X2	This pushbutton is reserved for use with an optional module.

1.3 THE DECTalk DIAGNOSTIC TESTS

When you turn on the power switch on the rack enclosure, the DECTalk DTC03 system performs a set of self-tests. The power supply and modules are automatically checked for problems.

Pressing the DL, CL, and ST pushbuttons on the modules also activates the self-tests. You can use these pushbuttons to run routine self-tests on individual modules.

The results of the tests are displayed on the module LEDs. The next two sections explain how to use the tests and how to interpret the results.

1.3.1 Power-Up Self-Test

At power-up, the self-test first checks the power supply. If no LEDs on the modules are on, check the power cord and the ac outlet. If they are fine, the power supply has failed. Call Digital's Field Service.

Then, if the LEDs are on, each module runs the test that completely checks the module logic and I/O ports. The test runs for about 2 seconds if the communications line is set at 9600 baud, or for about 30 seconds if the communications line is set for 110 baud. The test must end with the OK LED on continuously and the other three LEDs off. At this point, the module is ready to operate.

If the OK LED and any other LEDs are flashing, or if all the LEDs are off, the module has failed the self-test and must be replaced. Call Digital's Field Service.

1.3.2 Routine Self-Test

You can run a routine self-test on individual modules anytime during operation. The routine self-test checks the same things the power-up self-test checks, except the power supply.

To run the routine self-test, follow these steps.

1. Open the front door of the rack enclosure.
2. On the module you are checking, press the DL, CL, and ST pushbuttons *in that order*.

The LEDs on the module light for about 0.5 seconds, then go off for 1 second, and the SP LED flashes a few times.

If the module passes the test, the OK LED lights continuously.

If the module fails the test, the LEDs flash or stay off. Call Digital's Field Service.

3. The module repeats this test every 15 seconds as long as the ST pushbutton is pressed down. To stop the test, release the ST, DL, and CL pushbuttons *in that order*. If the module passes the test, it comes up ready to operate.

NOTE: Remember to release the ST, DL, and CL pushbuttons or the module will continue to run the self-test.

1.4 OPERATING MODE

The DECtalk module is ready to operate when its OK LED lights continuously. In this state, DECtalk is controlled by the host computer and is in operating mode.

When in operating mode, DECtalk is ready to process input commands from a telephone and control commands and ASCII text from the host computer. DECtalk can generate output speech transmission to the user. Chapter 2 describes how this process works.

2 HOW DECTalk WORKS

This chapter describes how DECTalk converts ASCII data into voice output.

2.1 CONVERTING TEXT TO SPEECH

You enter text and commands into a host computer by using a terminal. The host computer can then send this ASCII text to DECTalk through the I/O port. DECTalk converts this data into speech by a three-level process.

Level 1 First, DECTalk accepts text from the host computer and converts the text from one code into another. The text is in *ASCII format* when it enters DECTalk, and is converted to *phonemic code* for further processing.

Phonemic code uses the phonemic alphabet described in Chapter 7. Each symbol in the phonemic alphabet has only one pronunciation. DECTalk uses an internal dictionary and the rules of English pronunciation to do the conversion.

Level 2 Next, the phonemic code is converted into *synthesizer control commands*. These continuous variables control the pitch and timbre for the DECTalk voice.

Level 3 Finally, the *speech synthesizer* uses the control commands to generate a speech waveform.

In levels 2 and 3, a synthesizer control command is generated every 6.4 milliseconds, and the digital signal processor generates a speech waveform value every 100 microseconds. This process generates "frames" of speech. DECTalk acts somewhat like a TV picture, in that these frames of speech are presented to the listener just as frames of pictures are presented to the viewer. In both cases, the frames appear to be one continuous, unbroken sequence.

2.2 DEctalk SOFTWARE PROGRAM

The three-level process described in the last section happens in seven program modules (Figure 2-1). Each module is described briefly in the following paragraphs.

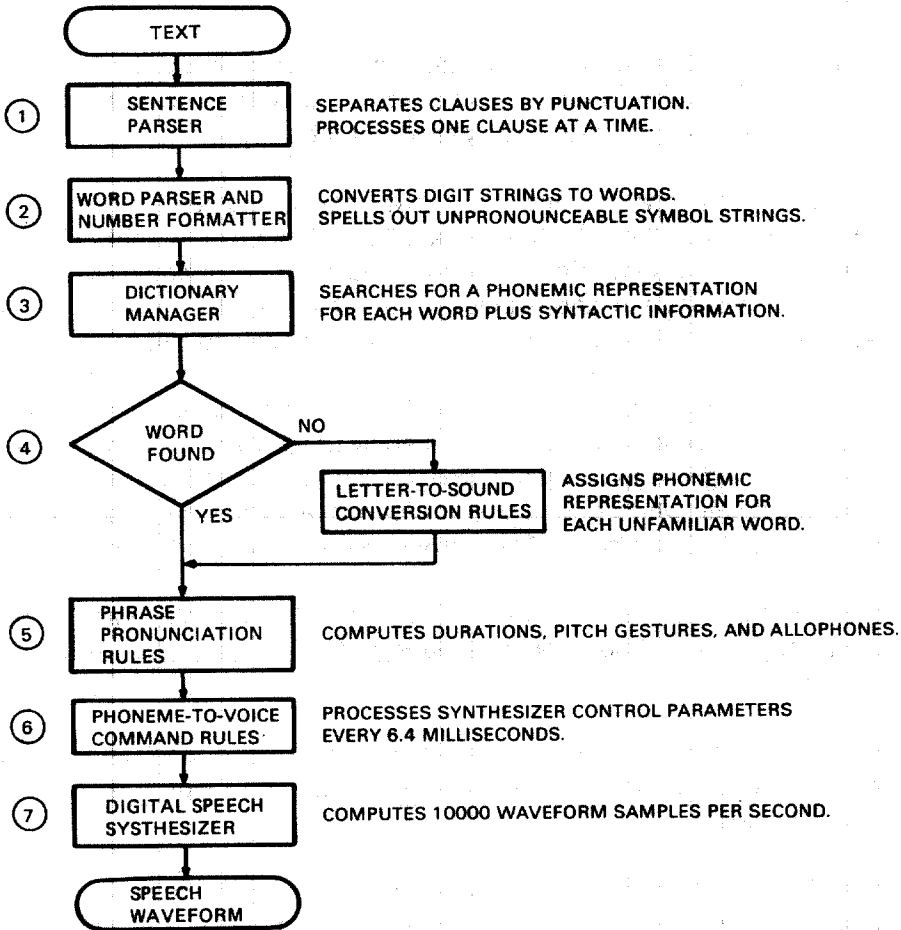

MA-0346-85

Figure 2-1 Text-to-Speech Conversion

Converting ASCII Text to Phonemic Code

1. A *sentence parser* breaks the input stream into separate words and locates some clause boundaries (indicated by commas and other punctuation marks). The sentence parser also recognizes and deals with phonemic symbols and commands that you may have added to the input text. Phonemics are discussed in Chapters 7 and 9.
2. A *word parser* breaks words into their component parts, yielding words in their final pronounceable form. Strings of text that do not form pronounceable English words are spelled out letter by letter.

A *number formatter* is used if the text contains numerals. The number formatter knows the rules for many common number formats and converts the numbers into English words. The number formatter also recognizes many common abbreviations, such as "lb." for "pound(s)." See Appendix C for more information on number-speaking rules.

3. A *dictionary manager* searches the pronunciation dictionaries. DECtalk has a built-in dictionary of many commonly used words. In some cases, a single spelling has two different pronunciations and DECtalk gives you a way to indicate which one to use in a particular sentence. See Chapter 7 and Appendix D for the DECtalk pronunciation rules and homographs.

DECtalk also has a user dictionary that can be loaded with words specific to an application. The user dictionary and its loading are described in Chapter 8.

4. A *letter-to-sound* module uses a set of English pronunciation rules to assign phonemic form and lexical stress patterns to words not found in the dictionary.

See Chapter 7 for ways to modify the phonemic form of words, and Chapter 9 for special voice qualities (such as emphasis and singing).

It is a good idea to program the host computer to automatically send DECtalk the correct phonemics for the mispronounced which are words important for a particular application.

5. A *phrase structure* module recombines all phonemic output from the dictionary search and other modules. Durations of phonemes and pitch commands are computed for the clause, and an appropriate allophone is selected for those phonemes that can be pronounced in more than one way.

Converting Phonemic Code to Synthesizer Control Commands

6. The *phoneme-to-voice* module processes clauses passed from the phrase structure module and converts them to control signals for the speech synthesizer.

This module modifies the clauses by changing the phonemes/allophones into parameters that determine the natural resonant frequencies of the vocal tract (formants), sound source amplitudes, and the like.

The *control parameters* are sent to the speech synthesizer for output.

Converting Control Commands to Speech

7. The *digital speech synthesizer* computes a speech waveform with acoustic characteristics that are determined by the synthesizer control commands received.

PART 2

HOW DECtalk PROGRAMMING WORKS

Chapter 3	Communicating with DECtalk	16
Chapter 4	Character Encoding and Setup Escape Sequences	29
Chapter 5	Maintenance and Test Commands	49
Chapter 6	Telephone Communications	57

3 COMMUNICATING WITH DECtalk

This chapter gives you an overview of DECtalk programming technique. It describes the types of data and commands DECtalk uses and how DECtalk communicates with a host computer.

3.1 PROGRAMMING GUIDELINES

DECtalk is an intelligent peripheral device, so the following guidelines apply.

- DECtalk is easy to control, because the internal DECtalk processor is sophisticated enough to perform complex operations with simple commands.
- You can select DECtalk's operating characteristics and have DECtalk answer questions about its status from the host computer. DECtalk can also inform the host computer of status changes. For example, DECtalk can tell the host computer if a connected telephone has been answered.
- DECtalk memory stores a substantial amount of useful information. For example, DECtalk has an extensive built-in pronunciation dictionary. You can also load a user-defined dictionary.

The following sections describe how DECtalk sends and receives information from the host computer. Figure 3-1 shows how DECtalk and a host computer communicate.

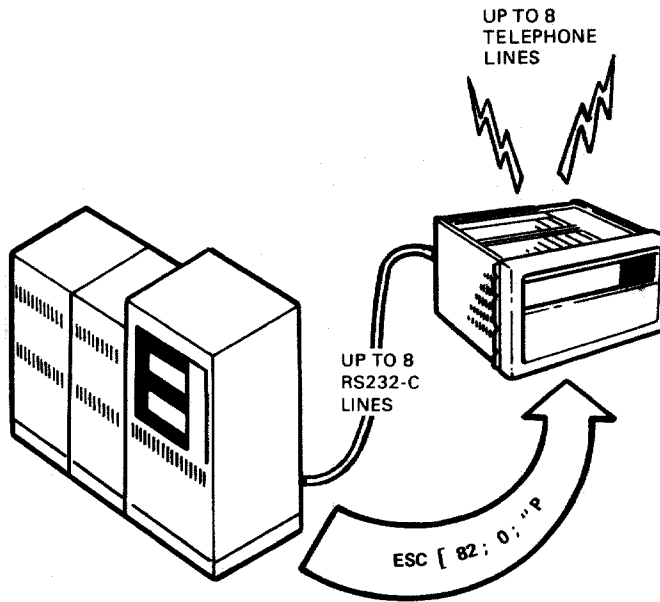

MA-0361-85

Figure 3-1 DECtalk-to-Host Communications

3.1.1 Types of Data

DECtalk can receive two types of data through its communications connector: text and commands.

Text is data that DECtalk will speak. Text consists of English-language sentences, phonemically spelled text, or a combination of both.

Commands are instructions to perform an action. Commands are not spoken by DECtalk.

You can send commands by using *escape sequences*, *control sequences* (CSI), and *device control strings* (DCS).

An escape sequence, CSI, or DCS starts with an ESC character, followed by a string of ASCII characters. DECtalk interprets the string as a special command. Character encoding and control functions are described in Chapter 4 of this manual.

3.2 USING ESCAPE SEQUENCES AND CONTROL CHARACTERS

This section describes the general syntax of escape and control sequences, and how to use them with DECtalk.

3.2.1 Escape Sequences

The following command is an example of an escape sequence. You can use this command to enable or disable speaking of text.

```
ESC P 0 ; 2 1 ; P3 z ESC \
```

NOTE: Escape sequences in this manual are spaced for clarity only. Spaces are not part of the actual escape sequences.

You can omit parameters with a value of 0. For example, you could send the above sequence as

```
ESC P ; 2 1 ; P3 z ESC \
```

NOTE: DECtalk does not send 0 parameters in its reply sequences. Because DECtalk suppresses parameters with a value of 0, DECtalk would send ESC P ; 31 ; P3 z ESC \ in response to the sequence in Figure 3-2 (assuming P3 is not 0). If P3 is 0, DECtalk would send ESC P ; 31 ; z ESC \.

DECtalk escape sequences have the following characteristics.

1. They begin with an ESC character.
2. The ESC character is followed by ASCII characters that define the command.
3. Every character in the command is important. You must enter the exact characters shown. For example, in the command above, the semicolons are part of the command. The letter z is lowercase; an uppercase Z has no meaning to DECtalk.
4. Some commands must end with a string terminator, ESC \. This manual includes ESC \ with all commands that require it.

NOTE: DECtalk ignores invalid sequences and commands.

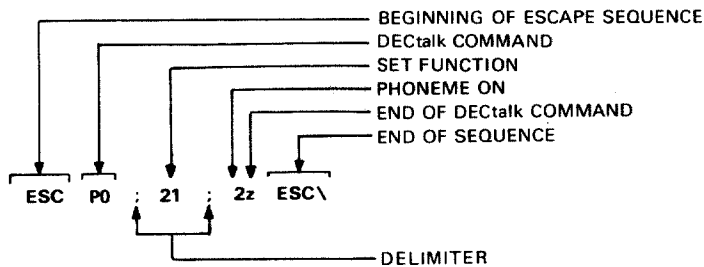

MA-7591-83B

Figure 3-2 Typical Escape Sequence Format

3.2.2 Escape Sequence Format

The following chapters describe the specific escape sequences used with DECTalk. This manual includes the following information with all escape sequences (Figure 3-2).

- Mnemonic
- ASCII characters
- Parameters
- Decimal value

Figure 3-3 shows the meaning of each part of a typical escape sequence.

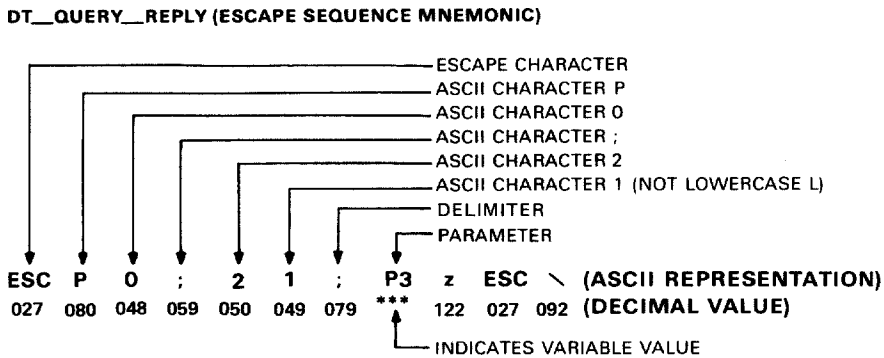

MA-7592-83B

Figure 3-3 Escape Sequence Representations

The *mnemonic* is a unique name (such as DT_INDEX) used to identify the sequences in this manual. Mnemonics do not have any direct programming significance; that is, DECtalk does not recognize a mnemonic name as a valid escape sequence. However, when you refer to escape sequences by mnemonic in program documentation and program variables, it simplifies editing and debugging.

The *ASCII characters* are the actual characters to use. Figures 3-2 and 3-3 give the examples of escape sequences in ASCII format. The escape character is represented by ESC in all sequences. The numbers that appear are actual ASCII characters, not numeric values.

Parameters in escape sequences are variables that can cause different DECtalk actions, depending on parameter values.

Parameters are represented in this manual by a capital P followed by a number. Parameters are always sent to and from DECtalk as a decimal number, in ASCII format.

An empty parameter is treated like a parameter with a value of 0. The sequences ESC P ; z and ESC P 0 ; 0 z are identical. *DECtalk never sends a 0 parameter.* However, the 0 parameters are always shown as explicit zeros in examples.

This manual lists possible parameter values in tables. Two methods are used to show parameter values.

1. Usually the ASCII character(s) appears (with the decimal value underneath as a check). Use the ASCII character(s) in the escape sequence.
2. Sometimes only a numeric value appears. You must convert the numeric value to a sequence of ASCII characters for the escape sequence.

The *decimal value* of each escape sequence character appears directly under the character, so you can verify the sequence characters. Parameters are marked with asterisks (***) , indicating that the value is variable.

Chapter 4 provides complete tables of all ASCII characters and their decimal, octal, and hexadecimal equivalents.

3.2.3 Special Characters

Some control characters (such as carriage return and backspace) have special meanings. Table 3-1 lists the special characters that DECtalk recognizes. DECtalk also recognizes SS2, SS3, CSI, DCS, and ST control characters. DECtalk ignores all other control characters. (See Section 4.3.2.)

Table 3-1 Special Characters and Host Communications

Character	Mnemonic	Decimal Value	Function
Backspace	BS	008	Overstrike. See Section 3.2.4.
Horizontal tab	HT	009	Same as a space, but inserts a comma pause to facilitate the reading of tabular data.
Line feed	LF	010	Same as a space.
Vertical tab	VT	011	Same as a space, but clears the current clause.
Form feed	FF	012	Same as a space.
Carriage return	CR	013	Same as a space.
Shift out	SO	014	Used in character set selection. See Section 4.4.1.
Shift in	SI	015	Used in character set selection. See Section 4.4.1.
Substitute	SUB	026	If a communication error occurs, DECtalk replaces the bad character with a SUB character. The SUB character acts as a clause terminator. See Section 3.4 for information on clause terminators.
Escape character	ESC	027	Introduces sequences.
Space	SP	032	Normal word terminator.

3.2.4 Effect of the Backspace (BS) Character

If DECtalk finds the backspace character in a word, it modifies the word according to the hierarchy of the characters involved, as follows.

1. Letters and digits (most important)
2. Punctuation
3. Underline character

The BS character allows DECtalk to process text containing overstrikes and underscores.

Here are several examples of DECtalk's processing (spaced for clarity).

Input	Pronounced as
a BS _	a
_ BS a	a
a BS b	b
ab BS BS de	de

3.3 DECtalk-COMPUTER COMMUNICATION

Programming DECtalk is similar to programming a smart terminal (such as a VT220). DECtalk and the host computer must exchange information according to fixed rules.

DECtalk does not process text until it reaches a clause boundary. Clause boundaries mark the end of phrases or sentences. DECtalk recognizes the following clause boundaries.

- A period, comma, exclamation point, and question mark are boundaries. Certain other punctuation characters, such as) and (, are also boundaries. If a period is used, DECtalk checks the characters after the period (because periods do not always mean the end of a sentence).
- A full buffer acts as a boundary. If DECtalk's temporary buffer begins to approach its fill limit (at about 32 words), DECtalk begins speaking what is in the buffer, as if a comma appeared in the text.
- A timeout is another boundary. If nothing is sent to DECtalk for 5 seconds, and there is text in the buffer, then DECtalk speaks all the text in the buffer as though a comma had been sent with the text.

Escape sequences represent (1) commands sent from the host computer to DECTalk, and (2) status replies sent from DECTalk to the host computer. All escape sequences begin with the ESC character; a sequence ends when the last character required for that sequence is sent. Do not use a carriage return or any other normal terminating character to terminate an escape sequence.

Figure 3-4 shows the data paths in DECTalk, as follows.

1. The DECTalk unit is in the center of the figure. The speech processor is part of the DECTalk unit, but is shown as a separate module.

2. Arrows show the direction of information flow. Notice that information from the telephone flows to the host computer and from the host computer to the speech processor. Information from the speech processor is sent to the telephone.
3. Each DECTalk escape sequence affects the flow of information within particular data paths. The switches within the data paths represent the points at which the escape sequences act. For example, the DT_STOP escape sequence affects the data flow from the host computer to the speech processor.
4. Because there are a large number of commands and parameters, they are grouped in boxes under the figure.

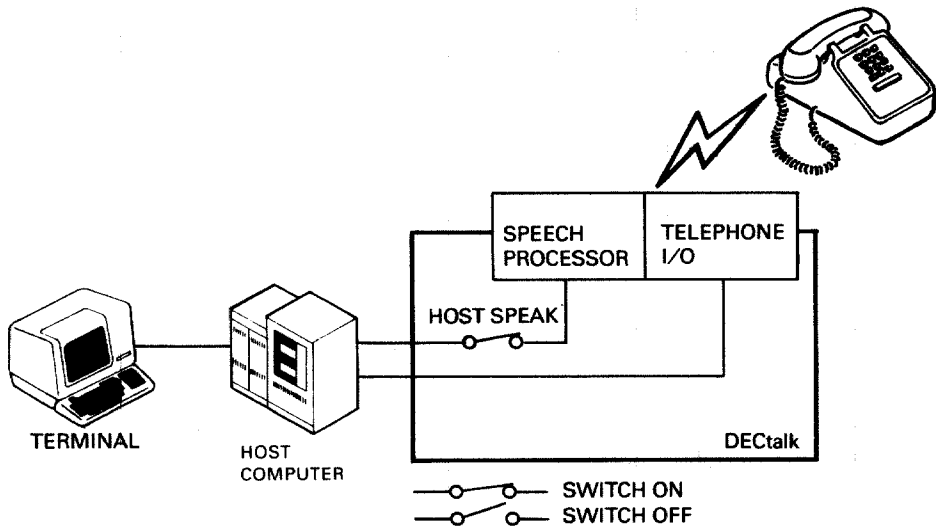
You can control and use DECTalk in many ways when it is connected to a host computer. The rest of this chapter, Sections 10.1 and 10.2, and the sample program in Appendix E describe a general programming method for DECTalk. If you are writing a control program for DECTalk, remember that your application and needs may not exactly match the descriptions that follow.



SPEECH PROCESSOR SEQUENCES

```
DT__MODE:MODE__SQUARE
DT__MODE:MODE__MINUS
DT__MODE:MODE__EUROPE
DT__MODE:MODE__SPELL
DT__PHOTEXT
```

TELEPHONE COMMUNICATIONS

```
DT__PHONE
DT__MASK
```

HOST SPEAK SEQUENCES

```
DT__STOP
DT__SPEAK
DT__SYNC
```

MA-0364-85

Figure 3-4 DECtalk and Host Computer Programming Interaction

3.3.1 DECtalk Setups

Each module in the DECtalk DTC03 system must be individually set up, as described in Appendix B. The following events may occur at power-up.

1. Programs may send a "What are you?" sequence to make sure DECtalk is available. DECtalk replies with a certain ID code to identify itself.
 - a. The device attribute request (Section 5.2) describes the "What are you?" sequence.
 - b. Set `MODE_SQUARE` on. This command ensures that phonemic code values are accepted. See the `DT_MODE` command in Section 4.6.2.
 - c. If you connect DECtalk to the public telephone network, select the correct telephone handling parameters. See Chapter 6 for these parameters.
2. You may have to set up the host computer (or the DECtalk communication line) for DECtalk commands. You must set up the computer for single-character, type-ahead input, and operating system XON/XOFF processing.

If your host computer cannot support single-character processing, you can use the `DT_MASK` command to permit line-at-a-time processing. See Section 6.2 for information on the keypad mask command (`DT_MASK`).

3. Other commands depend on the DECtalk environment, such as special text-to-speech commands.

3.3.2 Program Control

DECtalk is primarily a speech output device. It assumes the host computer will handle most of the necessary control operations (such as waiting for task completion and requesting status).

3.3.3 Data Synchronization

DECtalk's speech rate is much lower than the potential data transfer rate on the host communication line. A standard XON/XOFF flow control protocol is used to prevent the overflow of an input buffer on each module.

All received characters are stored in a 64-byte input buffer. DECtalk sends an XOFF character to the host computer when its input buffer is filled to a turn-off limit (32 characters), asking the host computer to stop sending data. Meanwhile, DECtalk continues to process the characters from the buffer. When DECtalk's input buffer empties to a turn-on level (16 characters), it sends an XON character asking the host computer to start sending data again.

DECtalk's input buffer is large enough so that the host computer can continue sending data at the highest speed (9600 baud) for up to 250 milliseconds after it receives the XOFF, without losing the data.

Figure 3-5 shows how DECtalk synchronizes data transfer with the host computer through XON/XOFF signals.

If the host computer does not stop sending data in time, the input buffer may overflow and characters may be lost. DECtalk does not give an audible warning of this overflow, except for the obvious garbling of partial words. The host computer can issue a device status request (DSR) command to determine if an input buffer overflow occurred.

Most operating systems have a HOSTSYNC option (or its equivalent) in their terminal characteristics. If this characteristic is set on the DECtalk communications line, the host computer handles XON and XOFF characters. If XON/XOFF coordination is not available, you may be able to avoid buffer overflow by using the DT_SYNC command to control the application program's output rate. However, Digital does not recommend this method because it is difficult and error-prone. Section 8.6 discusses the DT_SYNC command.

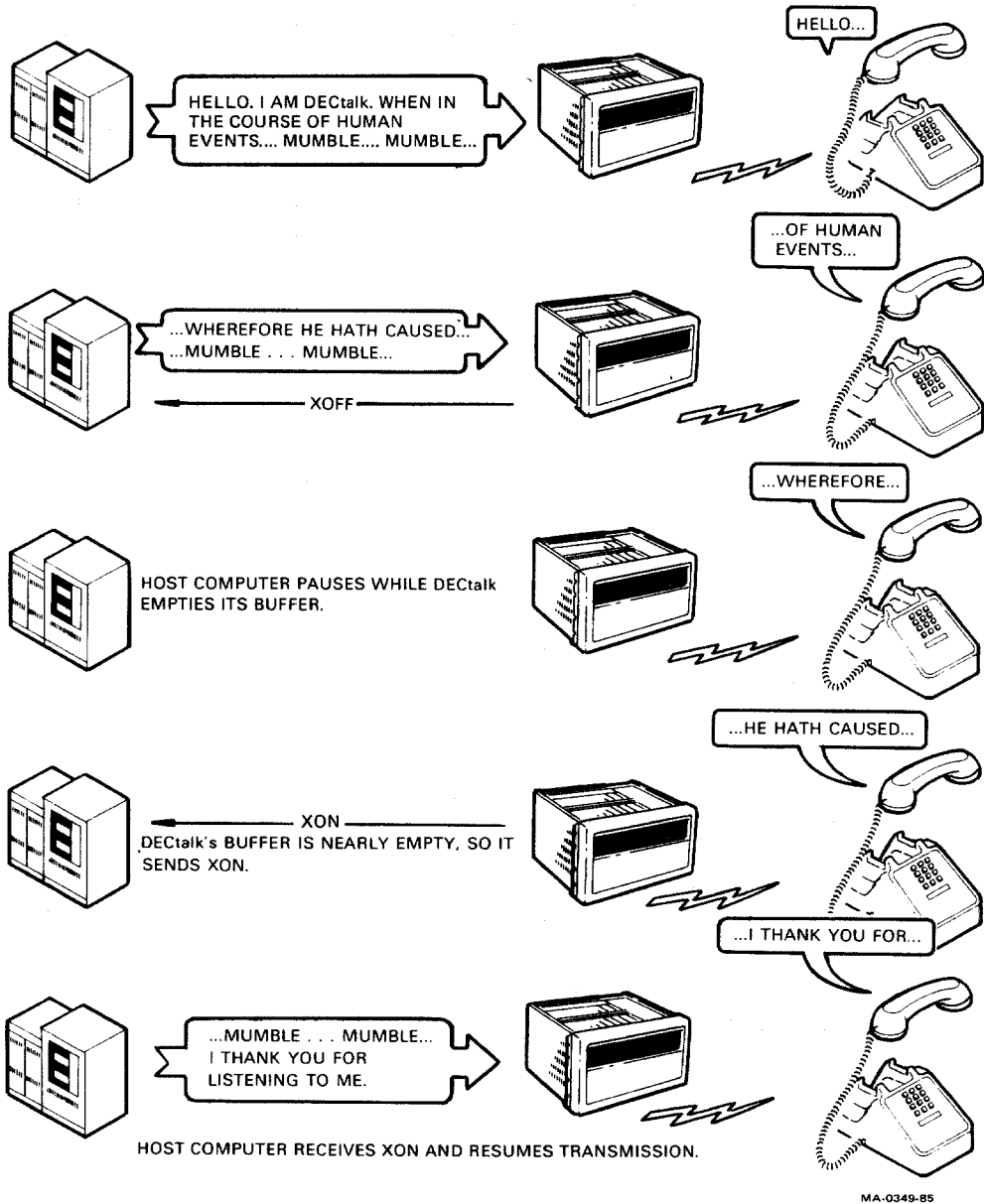

Figure 3-5 Synchronizing DECTalk and Host Communications

CHARACTER ENCODING AND SETUP ESCAPE SEQUENCES

4

DECtalk has several parameters that can be changed to conform to the operating environment. These parameters include the following.

- Line characteristics (such as line speed)
- Character sets (to send and receive information)
- Modes (to control DECTalk's interpretation of special characters and phonemic text)

There are also several testing and inquiry commands, described in Chapter 5.

4.1 SELECTING ASCII CHARACTER SETS

DECTalk is a computer terminal device, and conforms to the standards for computer terminals.

DECTalk uses the following rules for all character sets.

1. Uppercase and lowercase letters are considered the same (except for some abbreviations that are distinguished by case). For example, DECTalk speaks the letter G as "gee," not "uppercase gee." (See Appendix C.)
2. When found in words, foreign letters (as found in the multinational character set) are spoken as in English. For example, DECTalk speaks the letter ä as "ey umlaut."

- DECTalk operates with 7-bit and 8-bit data. You can translate or map 7-bit codes into 8-bit codes, and 8-bit codes into 7-bit codes (Figure 4-1). This mapping has no effect on spoken text. Table 4-1 gives the escape sequences that change DECTalk to 7-bit or 8-bit modes.

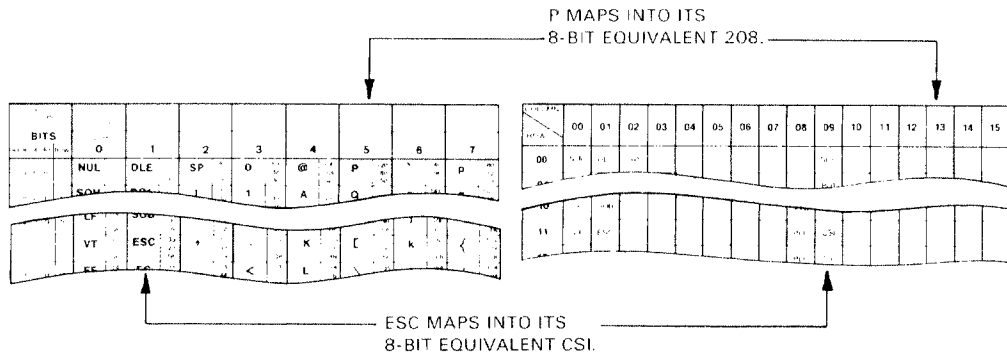

MA 7594 83

Figure 4-1 Mapping 7-Bit and 8-Bit Tables

Table 4-1 Selecting 7-Bit or 8-Bit Mode

Mnemonic	Escape Sequence	Function
S7C1T	ESC SP F 027 032 070	Select 7-bit C1 control character transmission.
S8C1T	ESC SP G 027 032 071	Select 8-bit C1 control character transmission. Ignored if the host communications line is <i>not</i> set to 8 bits.

4.2 CODING STANDARDS

DECtalk uses an 8-bit character encoding scheme and a 7-bit code extension technique that are compatible with the following ANSI and ISO standards. ANSI (American National Standards Institute) and ISO (International Organization for Standardization) specify the current standards for character encoding used in the communications industry.

Standard	Description
ANSI X3.4 – 1977	American Standard Code for Information Interchange (ASCII)
ISO 646 – 1977	7-Bit Coded Character Set for Information Processing Interchange
ANSI X3.41 – 1974	Code Extension Techniques for Use with the 7-Bit Coded Character Set of American Standard Code Information Interchange
ISO Draft International Standard 2022.2	7-Bit and 8-Bit Coded Character Sets – Code Extension Techniques
ANSI X3.32 – 1973	Graphic Representation of the Control Characters of American National Code for Information Interchange
ANSI X3.64 – 1979	Additional Controls for Use with American National Standard for Information Interchange
ISO Draft International Standard 6429.2	Additional Control Functions for Character Imaging Devices

4.3 CODE TABLES

A code table is a convenient way to represent 7-bit and 8-bit characters, because you can see groupings of characters and their relative codes clearly.

4.3.1 7-Bit ASCII Code Table

Figure 4-2 is the 7-bit ASCII code table. There are 128 positions corresponding to 128 character codes arranged in a matrix of 8 columns and 16 rows.

ROW	COLUMN																			
	0		1		2		3		4		5		6		7					
	BITS b7 b6 b5 b4 b3 b2 b1		0 0 0		0 0 1		0 1 0		0 1 1		1 0 0		1 0 1		1 1 0		1 1 1			
0	0	0	0	0	NUL	0 16 0	DLE	20 16 10	SP	40 32 20	0	60 48 30	@	100 64 40	P	120 80 50	,	140 96 60	p	160 112 70
1	0	0	0	1	SOH	1 17 1	DC1 (XON)	21 17 11	!	41 33 21	1	61 49 31	A	101 65 41	Q	121 81 51	a	141 97 61	q	161 113 71
2	0	0	1	0	STX	2 18 2	DC2	22 18 12	"	42 34 22	2	62 50 32	B	102 66 42	R	122 82 52	b	142 98 62	r	162 114 72
3	0	0	1	1	ETX	3 19 3	DC3 (XOFF)	23 19 13	#	43 35 23	3	63 51 33	C	103 67 43	S	123 83 53	c	143 99 63	s	163 115 73
4	0	1	0	0	EOT	4 20 4	DC4	24 20 14	\$	44 36 24	4	64 52 34	D	104 68 44	T	124 84 54	d	144 100 64	t	164 116 74
5	0	1	0	1	ENQ	5 21 5	NAK	25 21 15	%	45 37 25	5	65 53 35	E	105 69 45	U	125 85 55	e	145 101 65	u	165 117 75
6	0	1	1	0	ACK	6 18 6	SYN	26 22 16	&	46 38 26	6	66 54 36	F	106 70 46	V	126 86 56	f	146 102 66	v	166 118 76
7	0	1	1	1	BEL	7 23 7	ETB	27 23 17	'	47 39 27	7	67 55 37	G	107 71 47	W	127 87 57	g	147 103 67	w	167 119 77
8	1	0	0	0	BS	10 8 8	CAN	30 24 18	(50 40 28	8	70 56 38	H	110 72 48	X	130 88 58	h	150 104 68	x	170 120 78
9	1	0	0	1	HT	11 9 9	EM	31 25 19)	51 41 29	9	71 57 39	I	111 73 49	Y	131 89 59	i	151 105 69	y	171 121 79
10	1	0	1	0	LF	12 10 A	SUB	32 26 1A	*	52 42 2A	:	72 58 3A	J	112 74 4A	Z	132 90 5A	j	152 106 6A	z	172 122 7A
11	1	0	1	1	VT	13 11 B	ESC	33 27 1B	+	53 43 2B	;	73 59 3B	K	113 75 4B	[133 91 5B	k	153 107 6B	{	173 123 7B
12	1	1	0	0	FF	14 12 C	FS	34 28 1C	,	54 44 2C	<	74 60 3C	L	114 76 4C	\	134 92 5C	l	154 108 6C		174 124 7C
13	1	1	0	1	CR	15 13 D	GS	35 29 1D	-	55 45 2D	=	75 61 3D	M	115 77 4D]	135 93 5D	m	155 109 6D	}	175 125 7D
14	1	1	1	0	SO	16 14 E	RS	36 30 1E	.	56 46 2E	>	76 62 3E	N	116 78 4E	^	136 94 5E	n	156 110 6E	~	176 126 7E
15	1	1	1	1	SI	17 15 F	US	37 31 1F	/	57 47 2F	?	77 63 3F	O	117 79 4F	_	137 95 5F	o	157 111 6F	DEL	177 127 7F

KEY

CHARACTER	ESC	33	OCTAL
		27	DECIMAL
		1B	HEX

MA-0893A-83

Figure 4-2 7-Bit ASCII Code Table

Each row represents a possible value of the four least significant bits of a 7-bit code (Figure 4-3). Each column represents a possible value of the three most significant bits.

Figure 4-2 shows the octal, decimal, and hexadecimal code for each ASCII character. You can also represent any character by its position in the table. For example, the character H (column 4, row 8) can be represented as 4/8.

DECTalk processes received characters based on two character types defined by ANSI: graphic characters and control characters.

Graphic characters are the characters that can be displayed on an output device (video terminal or hardcopy printer). The ASCII graphic characters are in positions 2/1 through 7/14 of Figure 4-2. They include alphanumeric characters plus punctuation marks and various text symbols. Examples are C, n, ", !, +, and \$.

Control characters are single-byte codes that perform specific functions in data communications and text processing. The ASCII control characters are in positions 0/0 through 1/15 (columns 0 and 1) of Figure 4-2. Most control characters are silently ignored. The SP character (space, 2/0) can be considered either a graphic character or a control character depending on the context. DEL (7/15) is always used as a control character.

Control character codes and functions are standardized by ANSI. Examples of ASCII control characters with their ANSI-standard mnemonics are CR (carriage return), FF (form feed), and CAN (cancel).

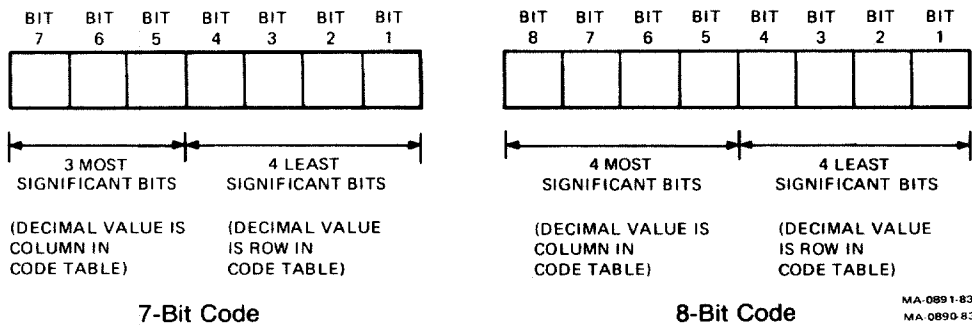
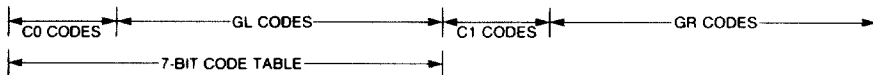

Figure 4-3 Data Word Representation

4.3.2 8-Bit Code Table

The above conventions can be generalized to the 8-bit character encoding used on DECTalk. Figure 4-4 shows the 8-bit code table. It has twice as many columns as the 7-bit table, because it contains 256 versus 128 code values.

COLUMN ROW	00	01	02	03	04	05	06	07	08	09	10	11	12	13	14	15
00	NUL	DLE	SP							DCS	///					
01	SOH	DC1								PU1						
02	STX	DC2								PU2						
03	ETX	DC3								STS						
04	EOT	DC4							IND	CCH						
05	ENQ	NAK							NEL	MW						
06	ACK	SYN							SSA	SPA						
07	BEL	ETB							ESA	EPA						
08	BS	CAN							HTS							
09	HT	EM							HTJ							
10	LF	SUB							VTS							
11	VT	ESC							PLD	CSI						
12	FF	FS							PLU	ST						
13	CR	GS							RI	OSC						
14	SO	RS							SS2	PM						
15	SI	US						DEL	SS3	APC						///



MA-0892-83

Figure 4-4 8-Bit Code Table

As with the 7-bit table, each row represents a possible value of the four least significant bits of an 8-bit code (Figure 4-3). Each column represents a possible value of the four most significant bits.

All codes on the left half of the 8-bit table (columns 0 through 7) are 7-bit compatible: their eighth bit is not set and can be ignored or assumed to be 0. You can use these codes in either a 7-bit or an 8-bit environment. All codes on the right half of the table (columns 8 through 15) have their eighth bit set. You can use these codes only in an 8-bit environment.

The 8-bit code table has two sets of control characters, C0 (control zero) and C1 (control one). The table also has two sets of graphic characters, GL (graphic left) and GR (graphic right).

The basic functions of the C0 and C1 codes are as defined by ANSI. C0 codes represent the ASCII control characters described earlier. The C0 codes are 7-bit compatible. The C1 codes represent 8-bit control characters that let you perform more functions than those possible with the C0 codes. C1 codes can be used directly only in an 8-bit environment. Some C1 code positions are left blank because their functions are not yet standardized.

? . In Figure 4-4, all control characters that are recognized by DECtalk are highlighted. All other controls are ignored.

The GL and GR sets of codes are reserved for graphic characters. There are 94 GL codes in positions 2/1 through 7/14 and 94 GR codes in positions 10/1 through 15/14. By ANSI standards, positions 10/0 and 15/15 are not used. You can use GL codes in 7-bit or 8-bit environments. You can use GR codes *only* in an 8-bit environment.

4.4 CHARACTER SETS

You cannot change the functions of the C0 or C1 codes. However, you can map different sets of graphic characters into the GL and GR areas of the code table.

DECtalk supports the U.S. ASCII (ASCII_G), DEC Supplemental, and U.K. National character sets. Figures 4-5, 4-6, and 4-7 are the code tables for the ASCII_G, DEC Supplemental, and U.K. National character sets respectively. These character sets are the only sets understood by DECtalk.

CHAPTER 4

ROW	COLUMN				0	1	2	3	4	5	6	7
	BITS				0 0 0 0	0 0 0 1	0 0 1 0	0 0 1 1	0 1 0 0	0 1 0 1	0 1 1 0	0 1 1 1
	b8	b7	b6	b5	b4	b3	b2	b1				
0	0	0	0	0	0	0	0	0	0	0	0	0
1	0	0	0	1	1	1	1	1	1	1	1	1
2	0	0	1	0	2	2	2	2	2	2	2	2
3	0	0	1	1	3	3	3	3	3	3	3	3
4	0	1	0	0	4	4	4	4	4	4	4	4
5	0	1	0	1	5	5	5	5	5	5	5	5
6	0	1	1	0	6	6	6	6	6	6	6	6
7	0	1	1	1	7	7	7	7	7	7	7	7
8	1	0	0	0	8	8	8	8	8	8	8	8
9	1	0	0	1	9	9	9	9	9	9	9	9
10	1	0	1	0	10	10	10	10	10	10	10	10
11	1	0	1	1	11	11	11	11	11	11	11	11
12	1	1	0	0	12	12	12	12	12	12	12	12
13	1	1	0	1	13	13	13	13	13	13	13	13
14	1	1	1	0	14	14	14	14	14	14	14	14
15	1	1	1	1	15	15	15	15	15	15	15	15

← C0 CODES	← GL CODES (ASCII GRAPHICS)
------------	-----------------------------

KEY

CHARACTER	ESC	33	OCTAL
		27	DECIMAL
		1B	HEX

MA-0893-83C

Figure 4-5 ASCII_G Character Set

CHARACTER ENCODING AND SETUP ESCAPE SEQUENCES

8		9		10		11		12		13		14		15		COLUMN				ROW			
1 0 0 0		1 0 0 1		1 0 1 0		1 0 1 1		1 1 0 0		1 1 0 1		1 1 1 0		1 1 1 1		b8	b7	b6	b5		b4	b3	b2
200 128 80		220 144 90		240 160 A0	°	260 176 80	À	300 192 C0		320 208 D0	à	340 224 E0		360 240 F0	0	0	0	0	0	0	0	0	0
201 129 81		221 145 91	í	241 161 A1	±	261 177 81	Á	301 193 C1	Ñ	321 209 D1	á	341 225 E1	ñ	361 241 F1	0	0	0	0	1				
202 130 82		222 146 92	ë	242 162 A2	2	262 178 82	Â	302 194 C2	Ò	322 210 D2	â	342 226 E2	ò	362 242 F2	0	0	0	1	0				
203 131 83		223 147 93	£	243 163 A3	3	263 179 83	Ã	303 195 C3	Ó	323 211 D3	ã	343 227 E3	ó	363 243 F3	0	0	0	1	1				
204 132 84		224 148 94		244 164 A4		264 180 84	Ä	304 196 C4	Ô	324 212 D4	ä	344 228 E4	ô	364 244 F4	0	1	0	0					
205 133 85		225 149 95	¥	245 165 A5	µ	265 181 85	Å	305 197 C5	Õ	325 213 D5	å	345 229 E5	õ	365 245 F5	0	1	0	1					
206 134 86		226 150 96		246 166 A6	¶	266 182 86	Æ	306 198 C6	Ö	326 214 D6	æ	346 230 E6	ö	366 246 F6	0	1	1	0					
207 135 87		227 151 97	§	247 167 A7	·	267 183 87	Ç	307 199 C7	Ç	327 215 D7	ç	347 231 E7	ç	367 247 F7	0	1	1	1					
210 136 88		230 152 98	ˆ	250 168 A8		270 184 88	È	310 200 C8	Ø	330 216 D8	ø	350 232 E8	ø	370 248 F8	1	0	0	0					
211 137 89		231 153 99	©	251 169 A9	1	271 185 89	É	311 201 C9	Ù	331 217 D9	é	351 233 E9	ù	371 249 F9	1	0	0	1					
212 138 8A		232 154 9A	®	252 170 AA	®	272 186 8A	Ê	312 202 CA	Ú	332 218 DA	ê	352 234 EA	ú	372 250 FA	1	0	1	0					
213 139 8B		233 155 9B	«	253 171 AB	»	273 187 8B	Ë	313 203 CB	Û	333 219 DB	ë	353 235 EB	û	373 251 FB	1	0	1	1					
214 140 8C		234 156 9C		254 172 AC	¼	274 188 8C	Ï	314 204 CC	Ü	334 220 DC	ï	354 236 EC	ü	374 252 FC	1	1	0	0					
215 141 8D		235 157 9D		255 173 AD	½	275 189 8D	Í	315 205 CD	Ý	335 221 DD	í	355 237 ED	ý	375 253 FD	1	1	0	1					
216 142 8E		236 158 9E		256 174 AE		276 190 8E	Î	316 206 CE		336 222 DE	î	356 238 EE		376 254 FE	1	1	1	0					
217 143 8F		237 159 9F		257 175 AF	¿	277 191 8F	Ï	317 207 CF	ß	337 223 DF	ï		377 255 FF	1	1	1	1						



MA-0894-83C

Figure 4-6 DEC Supplemental Character Set

CHAPTER 4

COLUMN		0	1	2	3	4	5	6	7
BITS		0 0 0	0 0 1	0 1 0	0 1 1	1 0 0	1 0 1	1 1 0	1 1 1
ROW	b7 b6 b5 b4 b3 b2 b1								
0	0 0 0 0 0	0 0 0	20 16 10	SP 32 20	0 48 30	@ 64 40	P 80 50	\ 96 60	p 112 70
1	0 0 0 0 1	1 1 1	21 17 11	! 41 33 21	1 61 49 31	A 101 85 41	Q 121 81 51	a 141 97 61	q 161 113 71
2	0 0 1 0	2 2 2	22 18 12	" 42 34 22	2 50 32	B 102 66 42	R 122 82 52	b 142 98 62	r 162 114 72
3	0 0 1 1	3 3 3	23 19 13	£ 43 35 23	3 63 51 33	C 103 67 43	S 123 83 53	c 143 99 63	s 163 115 73
4	0 1 0 0	4 4 4	24 20 14	\$ 44 36 24	4 52 34	D 104 68 44	T 124 84 54	d 144 100 64	t 164 116 74
5	0 1 0 1	5 5 5	25 21 15	% 45 37 25	5 65 53 35	E 105 69 45	U 125 85 55	e 145 101 65	u 165 117 75
6	0 1 1 0	6 6 6	26 22 16	& 46 38 26	6 66 54 36	F 106 70 46	V 126 86 56	f 146 102 66	v 166 118 76
7	0 1 1 1	7 7 7	27 23 17	' 47 39 27	7 67 55 37	G 107 71 47	W 127 87 57	g 147 103 67	w 167 119 77
8	1 0 0 0	8 8 8	30 24 18	(50 40 28	8 70 56 38	H 110 72 48	X 130 88 58	h 150 104 68	x 170 120 78
9	1 0 0 1	9 9 9	31 25 19) 51 41 29	9 71 57 39	I 111 73 49	Y 131 89 59	i 151 105 69	y 171 121 79
10	1 0 1 0	10 10 10	32 26 1A	* 52 42 2A	: 72 58 3A	J 112 74 4A	Z 132 90 5A	j 152 106 6A	z 172 122 7A
11	1 0 1 1	11 11 11	33 27 1B	+ 53 43 2B	; 73 59 3B	K 113 75 4B	[133 91 5B	k 153 107 6B	{ 173 123 7B
12	1 1 0 0	12 12 12	34 28 1C	, 54 44 2C	< 74 60 3C	L 114 76 4C	\ 134 92 5C	l 154 108 6C	 174 124 7C
13	1 1 0 1	13 13 13	35 29 1D	- 55 45 2D	= 75 61 3D	M 115 77 4D] 135 93 5D	m 155 109 6D	} 175 125 7D
14	1 1 1 0	14 14 14	36 30 1E	. 56 46 2E	> 76 62 3E	N 116 78 4E	^ 136 94 5E	n 156 110 6E	~ 176 126 7E
15	1 1 1 1	15 15 15	37 31 1F	/ 57 47 2F	? 77 63 3F	O 117 79 4F	_ 137 95 5F	o 157 111 6F	DEL 177 127 7F

KEY

CHARACTER	ESC	33	OCTAL
		27	DECIMAL
		1B	HEX

.MA-0893-835

Figure 4-7 U.K. National Character Set

4.4.1 Designating Alternate Graphic Sets

DECtalk has four alternate graphic character sets, called G0, G1, G2, and G3. Before a character set can be invoked (used), it must be designated (loaded) into one of the four alternate sets.

At power-up, DECTalk designates the ASCII_G character set into G0 and G1, and designates the DEC Supplemental character set into G2 and G3. You can modify these default designations by using the sequences in Table 4-2. Figures 4-8 and 4-9 show how you can designate the character sets.

Table 4-2 Invoking G-Sets

Command	Mnemonic	Escape Sequence	Graphics Set	Table Position
Locking shift 0	LS0	SI 015	G0	GL
Locking shift 1	LS1	SO 014	G1	GL
Single shift 2	SS2	ESC N 027 078	G2*	GL
Single shift 3	SS3	ESC O 027 079	G3*	GL
Locking shift 2	LS2	ESC n 027 110	G2	GL
Locking shift 3	LS3	ESC o 027 111	G3	GL
Locking shift 1 right	LS1R	ESC ~ 027 126	G1	GR
Locking shift 2 right	LS2R	ESC } 027 125	G2	GR
Locking shift 3 right	LS3R	ESC 027 124	G3	GR

* SS2 (single shift 2) and SS3 (single shift 3) are special cases. These commands select the next character value from the G2 or G3 set, respectively, regardless of the setting of the eighth bit.

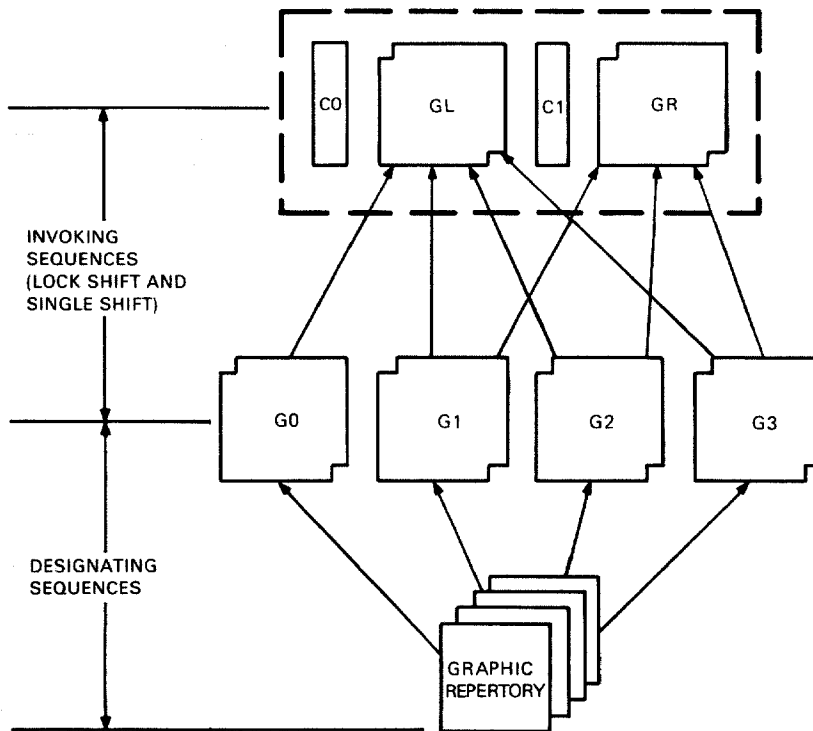

MA-0279A-82

Figure 4-8 Loading 8-Bit Characters

CHARACTER ENCODING AND SETUP ESCAPE SEQUENCES

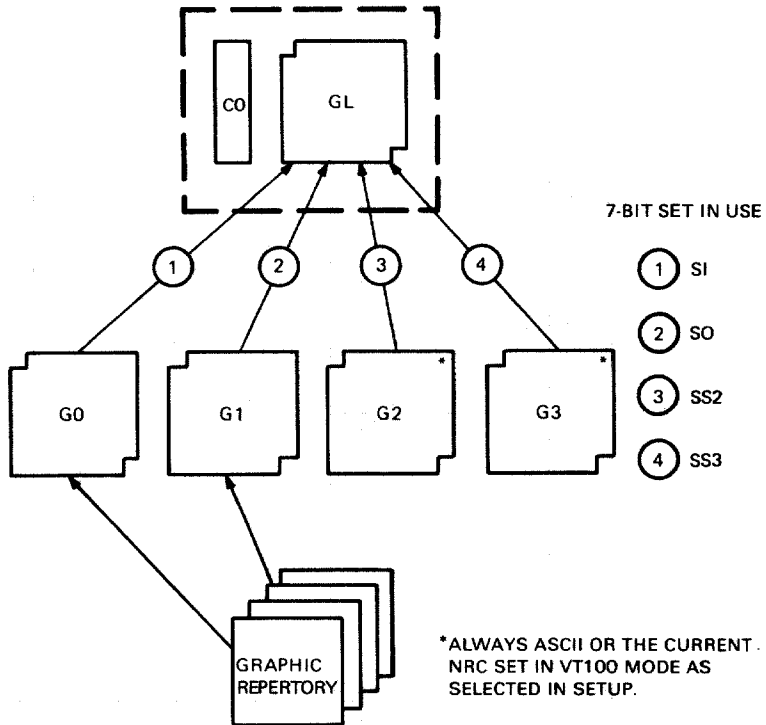

MA-0280A-82

Figure 4-9 Loading 7-Bit Characters

4.4.2 Invoking Graphic Sets into GL and GR

Character sets that have been designated into one of the four G-sets may be used by invoking the set into the GL or GR areas of the code table.

At power-up, DECTalk invokes the G0 character set (which holds ASCII_G) into GL, and the G2 character set (which holds DEC Supplemental) into GR. You can modify these default invocations by using the sequences in Table 4-3.

Table 4-3 Designating Character Sets

Character Set	G0	G1	G2	G3
ASCII_G	ESC (B 027 040 066	ESC) B 027 041 066	ESC * B 027 042 066	ESC + B 027 043 066
U.S. Supplemental	ESC (< 027 040 060	ESC) < 027 041 060	ESC * < 027 042 060	ESC + < 027 043 060
U.K. National	ESC (A 027 040 065	ESC) A 027 041 065	ESC * A 027 042 065	ESC + A 027 043 065

4.4.3 Character Processing

In 7-bit mode, characters received from the host computer are either C0 control characters or GL graphic characters. All C0 control characters are interpreted as described in Section 3.2.3. All GL graphic characters are processed *according to the rules for the character set currently invoked into GL*.

In 8-bit mode, characters received from the host computer can also be C1 control characters or GR graphic characters. All C1 control characters are interpreted as control functions. All GR graphic characters are processed *according to the rules for the character set currently invoked into GR*.

At power-up, due to the default designations and invocations, DECTalk processes characters in a way that is compatible with Digital's other terminal products.

4.5 CONTROL FUNCTIONS

You can express control functions as single-byte or multibyte codes.

The single-byte codes are the C0 and C1 control characters. Your program can perform a limited number of functions with C0 characters. C1 characters give you a few more functions, but your program can use them directly *only* in an 8-bit environment.

Multibyte codes represent far more functions because of the variety of code combinations possible. These codes are called escape sequences, control sequences, and device control strings.

4.5.1 Escape Sequences

An escape sequence is a sequence of one or more ASCII graphic characters preceded by the C0 character ESC (027). For example,

```
ESC ( B
027 040 066
```

is an escape sequence that requests DECtalk to designate the ASCII_G character set into G0.

Because escape sequences use only 7-bit characters, you can use them in a 7-bit or 8-bit environment.

Escape sequences have an important, special use. ANSI permits code extension techniques to extend 7-bit control functions. In particular, you can use two-byte escape sequences as 7-bit code extensions to express each of the C1 control codes.

You can express any C1 control character as a two-character escape sequence in which the second character has a code that is 40 (hexadecimal) or 64 (decimal) less than that of the C1 character. Conversely, you can make any escape sequence whose second character is in the range 4/0 through 5/15 one byte shorter (if running in the 8-bit mode) by removing the ESC and adding 40 (hexadecimal) or 64 (decimal) to the code of the second character, thereby generating an 8-bit control character.

CHAPTER 4

For example, the C1 characters CSI, SS3, and DCS can be expressed as follows.

C1 Character	7-Bit Extension Equivalent (escape sequence)
CSI 155	ESC [027 091
SS3 143	ESC O 027 079
DCS 144	ESC P 027 080

4.5.2 Control Sequences

A control sequence is a sequence of one or more ASCII graphic characters preceded by the CSI symbol (9/11). CSI can also be expressed as the 7-bit extension code ESC [. For example, the following control sequence requests a device status report from DECTalk.

```
CSI 5 n  
155 053 110
```

or

```
ESC [ 5 n  
027 091 053 110
```

A sequence starting with CSI can only be used in an 8-bit environment because CSI is a C1 control character.

4.5.3 Device Control Strings

A device control string is a delimited string of characters that are used in a data stream as a logical entity for control purposes. It consists of an opening delimiter (DCS introducer), a command string (data), and a closing delimiter (a string terminator or ST).

DCS (9/0) is an 8-bit control character. You can also express it as ESC P when coding for a 7-bit system. ST (9/12) can also be expressed in a 7-bit environment as ESC \. For example, the following instruction allows DECtalk to speak phonemic text.

```
DCS 0 ; 0 z ST
144 048 059 048 122 156
```

or

```
ESC P 0 ; 0 z ESC \
027 080 048 059 048 122 027 092
```

4.6 WORKING WITH 7-BIT AND 8-BIT ENVIRONMENTS

DECtalk supports both 7-bit and 8-bit communication techniques. To take advantage of DECtalk's 8-bit character set, your program and communication environment must be 8-bit compatible.

4.6.1 7-Bit and 8-Bit C1 Controls

Communication parameters are set up through two switches on the DECtalk module. (See Appendix B.) Switches SW4 and SW5 determine if the basic transmission and reception path is set for 7- or 8-bit communication. Four operating modes are possible:

1. 7 data bits and even parity
2. 7 data bits and odd parity
3. 7 data bits and ignored parity (8 bit, no parity, and ignored most significant bit)
4. 8 data bits with no parity

If one of the first three modes is set, you cannot send 8-bit characters to DECtalk, and DECtalk will always send C1 control characters in their 7-bit format.

If the communication parameters are set for 8-bit mode, then full 8-bit format (controls and data) is allowed. Characters in the C1 and GR sets are treated as such. You can use special escape sequences (S7C1T and S8C1T) to control the transmission format of C1 control characters. At power-up, DECtalk simulates the S8C1T sequence.

The S7C1T sequence causes DECtalk to send all C1 control characters in 7-bit format.

```
ESC SP F
027 032 070
```

The S8C1T sequence causes DECtalk to send all C1 control characters in 8-bit format. This sequence is ignored if the transmission and reception path is set to 7-bit mode.

```
ESC SP G
027 032 071
```

4.6.2 Mode Selection (DT_MODE)

The DT_MODE command provides a number of options to control how DECtalk handles particular characters in spoken text. The general DT_MODE escape sequence is as follows.

```
ESC P 0 ; 8 2 ; P3 ; P4 z ESC \
027 080 048 059 056 050 059 *** 059 *** 122 027 092
```

The P3 parameter is interpreted as a set of flag bits. P3 uses only four flags (Table 4-4).

At power-up, MODE_SQUARE is set (that is, the square brackets [and] are used as phonemic delimiters), and all other modes are cleared.

The P4 parameter controls the interpretation of P3 as follows.

If P4 is 0, then P3 changes the mode.

If P4 is 1, then P3 is a set of bits (flags) to be set in the mode.

If P4 is 2, then P3 is a set of bits (flags) to be cleared in the mode.

Table 4-4 DT_MODE Parameters

Mnemonic	Value	Function
P3 Parameter		
MODE_SQUARE	1	When this flag is set, DECtalk interprets [and] as phonemic delimiters. Otherwise, [and] are ordinary characters.
MODE_MINUS	4	When this flag is set, DECtalk pronounces the hyphen (-) character as "minus." Otherwise, it is pronounced "dash."
MODE_EUROPE	8	When this flag is set, DECtalk uses the comma (,) as the separator between the integer and fraction part of a number, and the period (.) as the character to separate three-digit blocks in long digit strings. For example: 1.255 (U.S.A.) is 1,255 (Europe) 125,873 (U.S.A.) is 125.873 (Europe)
MODE_SPELL	16	When this flag is set, DECtalk spells all words. The words are split up according to the usual rules. Standard word boundary pauses are used between letters, and comma pauses are used between words.
P4 Parameter		
-	0	Assign mode.
-	1	Set bits (flags).
-	2	Clear bits (flags).

CHAPTER 4

Use the following method to get the P3 value.

1. Add up the values of the MODE flags in Table 4-4 that you want to use.
2. Convert the sum to ASCII digits. Use these digits in place of P3 in the escape sequence.

For example, assume you want to set `MODE_SQUARE` and `MODE_MINUS`, and leave the other flags unchanged.

<code>MODE_SQUARE</code>	1
<code>MODE_MINUS</code>	+4

Desired P3 value =	5

Enter the P3 value 5, and then the P4 value 1. The resulting escape sequence is as follows.

```
ESC P 0 ; 8 2 ; 5 ; 1 z ESC \  
027 080 048 059 056 050 059 053 059 049 122 027 092
```

DECtalk will have the `MODE_SQUARE` and `MODE_MINUS` features enabled.

MAINTENANCE AND TEST COMMANDS **5**

DECtalk uses a set of commands that identify its configuration and certain operating features. These commands also help to test a DECtalk unit remotely. Most of these commands have an inquiry-response format. DECtalk returns an answer to the host computer after the action is complete (or in response to a pure inquiry).

5.1 CONFORMANCE LEVEL REQUEST (DECSCSCL)

Device conformance (or compatibility) level sets the level of interface compatibility and determines the specific functions a device can perform. DECtalk is a level 2 speech output device that can run in level 1 compatibility mode.

You can use the following sequence to set the conformance level.

```
ESC [ P1 ; P2 " p  
037 091 *** 059 *** 034 112
```

The P1 parameter must be either 81 (for level 1) or 82 (for level 2).

The P2 parameter selects the C1 control transmit format. It is either 0 (default setting, 8 bits), 1 (7 bits), or 2 (8 bits). The 0 and 2 parameters are ignored if the communication channel is set for 7 bits.

You can find out the DECtalk conformance level by using a DA primary command shown in Section 5.2.1. Because the conformance level affects how text is processed (in particular, it determines the interpretation of the `MODE_EUROPE` and `MODE_SPELL` commands), the DECSCSCL command performs an implied `DT_SYNC` command.

5.2 DEVICE ATTRIBUTE REQUESTS

DECtalk has two commands that may be used for device identification.

5.2.1 Device Attribute Request (DA Primary)

The device attribute request escape sequence is as follows.

```
ESC [ c
027 091 099
```

DECtalk identifies itself by sending the following status reply sequence.

```
ESC [ ? 8 2 ; 2 ; 3 c
027 091 063 056 050 059 050 059 051 099
```

This DA response provides the device code (82) to indicate that DECtalk is a level 2 device, and also shows wink detection (code 2) and call progress (code 3) extensions.

5.2.2 Device Attribute Request (DA Secondary)

The secondary DA request escape sequence helps to identify the hardware/firmware configuration of the DECtalk unit.

```
ESC > c
027 062 099
```

DECtalk responds with the following status sequence.

```
ESC > 1 2 ; 1 0 ; 1 c
027 062 049 050 059 049 048 059 049 099
```

The first parameter is the hardware identification code. For DECtalk, this code is 12.

The second parameter identifies the firmware version number. In this case, the code 10 indicates version 1.0 of the firmware.

The third parameter is 1 to identify the language spoken by the DECtalk unit as American English.

5.3 DEVICE TEST AND STATUS

A special set of escape sequences run DECTalk hardware self-tests. Another set of escape sequences forces DECTalk to return status reports. The following paragraphs describe these sequences.

5.3.1 DECTalk Power-Up Status

You can reset DECTalk to its power-up state. The method you use to reset DECTalk may affect the operating features. You can reset DECTalk with any of the following methods. This section describes methods 2 through 4.

1. Power-up (PUP) is the state that DECTalk is in when first turned on.
2. Return to initial state (RIS) is a hard reset you can request by using an escape sequence.
3. Soft reset (DECSTR) is a partial reset you can request by using a control sequence.
4. Nonvolatile memory reset (DECNVR) is included for compatability with earlier DECTalk devices.

Table 5-1 lists the DECTalk factory default settings.

Table 5-2 lists some other DECTalk actions performed through listed reset methods.

Table 5-1 Restoring DECTalk Default Operating Features

Feature	Factory Default	Restored from Memory by
Host communications line speed	9600 baud	PUP, RIS
Host communications line format	Ignored parity	PUP, RIS
Host C1 transmit mode	7 bit	PUP, RIS
Keypad mask	All 0	PUP, RIS

Table 5-2 DECTalk Actions Performed at Resets

DECTalk Action	Performed by
Implied DT_SPEAK.	PUP, RIS, DECSTR
Hang up telephone.	PUP, RIS, DECSTR
Delete user dictionary.	PUP, RIS
Flush all pending text.	PUP, RIS, DECSTR
Turn on host speech.	RIS, DECSTR
Conformance level default.	PUP, RIS
Character setting default.	PUP, RIS, DECSTR

5.3.2 Device Self-Tests (DECTST)

You can use this sequence to initiate DECTalk self-tests remotely. Appendix B shows how to perform the self-test by using the test pushbuttons on a DECTalk module.

The self-test control sequence is as follows.

```

ESC [ 5 ; P2 y
027 091 053 059 *** 121

```

The first parameter is 5 to specify the DECTalk private test set.

The P2 parameter specifies the test to be performed (Table 5-3).

The TEST_POWER parameter (P2 = 1) causes DECTalk to rerun its power-up initialization and test sequences. All DECTalk operating features return to the power-up state; the telephone is hung up, the user dictionary is deleted, and all features are reset to their power-up values.

The built-in (canned) message gives you a quick check of the DECTalk system. The message includes the version number of the DECTalk firmware.

If you try to run an unknown test, you will get a “bad private” error.

Table 5-3 Self-Test Parameters

Mnemonic	Value	Function
TEST_POWER	1 049	Rerun power-up self-tests.
TEST_HDATA	2 050	Run host data line loopback test.
TEST_HCONTROL	3 051	Run host control line loopback test.
TEST_SPEAK	5 053	Speak a built-in (canned) message.

5.3.3 Device Status Request (DSR) (Brief Report)

The brief DSR control sequence is as follows.

```
ESC [ 5 n
027 091 053 110
```

If no malfunctions are detected, DECtalk replies with the following sequence.

```
ESC [ 0 n
027 091 048 110
```

If a malfunction is detected, DECtalk replies with the following sequence.

```
ESC [ 3 n
027 091 051 110
```

Applications can use this brief DSR format in most cases, because a brief request does not reset any of DECtalk's internal error flags. The following extended DSR format is useful when a malfunction is detected.

5.3.4 Device Status Request (DSR) (Extended Report)

The extended DSR control sequence is as follows.

```
ESC [ n
027 091 110
```

If no malfunctions are detected, DECtalk replies with one of two sequences. If this is the first extended DSR since DECtalk was powered up (a "rerun" power-up self-test counts as an initial power-up), DECtalk replies with the following sequences.

```
ESC [ 0 n
027 091 048 110
```

```
ESC [ ? 2 1 n
027 091 063 050 049 110
```

For later requests, DECtalk replies with the following sequences.

```
ESC [ 0 n
027 091 048 110
```

```
ESC [ ? 2 0 n
027 091 063 050 048 110
```

If a malfunction is detected, DECtalk sends the following sequences.

```
ESC [ 3 n
027 091 051 110
```

```
ESC [ ? P1 ; Pn n
027 091 063 *** 059 *** 110
```

Table 5-4 lists Pn error codes.

NOTE: The extended status request sequence resets the error flags.

Table 5-4 DSR (Extended Report) Error Codes

Code	Description
2 2 050 050	Communication failed.
2 3 050 051	Input buffer overflowed.
2 4 050 052	Last NVR operation failed.
2 5 050 053	Error is in phonemic transcription.
2 6 050 054	Error is in DECTalk private control sequence.
2 7 050 055	Last DECTST failed.

5.3.5 Reset to Initial State (RIS)

Tables 5-1 and 5-2 show how RIS affects DECTalk. The RIS escape sequence is as follows.

```
ESC c  
027 099
```

This sequence resets DECTalk to its power-up state. The character set selections are returned to their default values and the conformance level is reset to level 2.

All pending, unspoken text is lost. All user-defined dictionary entries are deleted. The telephone is returned to the on-hook state. The RIS sequence always turns on host speech.

5.3.6 Soft Terminal Reset (DECSTR)

Table 5-2 shows how the soft terminal reset affects DECtalk. The DECSTR control sequence is as follows.

```
ESC [ ! p
027 091 033 112
```

This sequence resets DECtalk to its power-up state. The user-loadable dictionary and the conformance level are *not* affected.

However, as with RIS, the character set selections are returned to their default status, all pending, unspoken text is lost, and the telephone returns to the on-hook state.

The DECSTR sequence always turns on host speech.

5.3.7 NVR Control (DECNVR)

DECtalk does not contain an NVR (nonvolatile RAM). However, it “understands” the NVR control sequence, so that the programs that attempt to manipulate the NVR will get the appropriate error responses. The DECNVR sequence is as follows.

```
ESC [ P1 ; P2 ! r
027 091 *** 059 *** 033 114
```

The P1 parameter selects the type of operation (0 = recall data from memory, 1 = store data in memory).

The P2 parameter specifies which NVR memory to use (0 = read/write user memory, 1 = read-only factory-default memory).

Most parameter combinations in the control sequence fail. The only valid combination is the “recall data from default memory” when P1 = 0 and P2 = 1. The function of this combination is identical to the soft reset (DECSTR).

DECtalk remembers the success or failure status of the last NVR operation command. A device status request (DSR) sequence can check this status.

TELEPHONE COMMUNICATIONS

6

You can connect DECtalk to the public telephone system to provide a dial-up link between remote users on telephones and a computer application program. DECtalk sends and receives information as a link between a remote user and the host computer.

DECtalk communicates with the phone through the voice circuits, passing spoken data to the listener. DECtalk passes information back to the host computer as ordinary ASCII characters, and as escape sequences. The user can communicate with the host computer (through DECtalk) by using the Touch-Tone keypad, if available.

In the United States and Canada, DECtalk has a built-in telephone line interface that supports tone detection, pulse and tone (Touch-Tone) dialing, "wink" detection, and a simple call progress detection system. Wink detection lets the host computer determine that a caller has hung up much earlier than is possible by using only timeouts. The wink detection function permits DECtalk units to service a much larger volume of telephone data traffic.

6.1 TELEPHONE MANAGEMENT (DT_PHONE)

This multifunction control sequence takes one or more parameters and controls the attached telephone and Touch-Tone keypad interface. The DT_PHONE escape sequence is as follows.

```
ESC P 0 ; 6 0 ; P3 z ESC \
027 080 048 059 054 048 059 *** 122 027 092
```

The parameters, starting at P3, act as a list of telephone commands and are executed in sequence (from left to right). Table 6-1 lists the valid P3 parameters.

The dialing commands have a dialer control string between the z and the string terminator.

A single DT_PHONE sequence can perform several commands. Some commands (such as enable autoanswer) can take additional parameters.

All DT_PHONE commands return a status report to the host computer in the following format. Table 6-2 lists the valid P3 status values.

```
ESC P 0 ; 7 0 ; P3 z ESC \
027 080 048 059 055 048 059 *** 122 027 092
```

Telephone keypad characters are sent as text, not escape sequences.

The R3_PH_TIMEOUT and R3_PH_WINK reply sequences are sent asynchronously. That is, the reply sequence may arrive as unrequested input, and the application program must be ready to receive them.

Table 6-1 DT_PHONE Parameters

Mnemonic	Value	Function
PH_NOP	0 048	No operation or send a telephone status report.
PH_ANSWER	1 0 049 048	Enable autoanswer of the telephone; disable the keypad, timer, and wink detector.
PH_HANGUP	1 1 049 049	Hang up the telephone and disable the keypad, timer, and wink detector.
PH_KEYPAD	2 0 050 048	Enable the keypad and select direct keypad decoding; disable the timer.
PH_NOKEYPAD	2 1 050 049	Disable the keypad (without hanging up the telephone) and timer.
PH_STOPPAD	2 2 050 050	Enable the keypad and special autostop mode.
PH_TIMEOUT	3 0 051 048	Enable timeouts on telephone keypad input. Timeout equals P4 (next after P3) parameter value.
PH_TONE_DIAL	4 0 052 048	Dial an outgoing phone call by using Touch-Tone dialing.
PH_PULSE_DIAL	4 1 052 049	Dial an outgoing phone call by using pulse dialing.
PH_WINK	5 0 053 048	Enable the wink detection.
PH_NOWINK	5 1 053 049	Disable the wink detection.

Table 6-2 Phone Status Reply Codes

Mnemonic	Value	Function
R3_PH_ONHOOK	0 048	Telephone is on the hook (hung up).
R3_PH_OFFHOOK	1 049	Telephone is off the hook (active).
R3_PH_TIMEOUT	2 050	No response after timeout command.
R3_PH_TOOLONG	3 051	Number dialed is longer than 256 characters.
R3_PH_WINK	4 052	A wink is detected on the line.
R3_PH_NODIAL	5 053	No dial tone (call progress W), or unexpected dial tone (call progress X).
R3_PH_BUSY	6 054	The telephone line is busy.
R3_PH_NOANSWER	7 055	Nobody answered the call (timeout).

6.1.1 PH_ANSWER

DECtalk is set up to answer incoming phone calls. The parameter that follows the PH_ANSWER command parameter indicates the number of rings to wait before answering the telephone. A parameter of 0 or 1 means answer the telephone after the first ring; 2 means answer after two rings, and so on.

If the telephone is off-hook when the host sends a PH_ANSWER parameter, DECtalk hangs up the telephone (disconnects any active call) before executing the PH_ANSWER command. This command also disables the telephone keypad, the timeout, and the wink detection feature.

DECtalk sends two status replies to a PH_ANSWER request. The first status reply (which is sent immediately) informs the host computer that the DT_PHONE command was correctly received. The second reply (which is sent when the telephone is actually answered) informs the host computer that the telephone has actually been answered.

DECtalk stops waiting for incoming calls whenever the host computer sends PH_HANGUP, PH_TONE_DIAL, PH_PULSE_DIAL, RIS, or DECSTR.

6.1.2 PH_HANGUP

This command hangs up the telephone. The status reply is delayed until the telephone is actually back on-hook (disconnected). The host computer should wait for the R3_PH_ONHOOK reply before sending other commands to DECtalk.

This command disables the telephone keypad, the timeout, and the wink detection feature.

6.1.3 PH_KEYPAD

This command enables the telephone keypad. The request is ignored if the phone is inactive (on-hook); however, DECTalk returns an R3_PH_ONHOOK status reply. The command also disables the timeout function.

The characters received from the keypad look like ordinary ASCII characters. In a typical keypad, the characters are 0123456789*#. Some keypads have four extra buttons that generate the characters ABCD. These buttons are located as follows.

- A to the right of 3
- B to the right of 6
- C to the right of 9
- D to the right of #

6.1.4 PH_NOKEYPAD

This command disables the telephone keypad, but maintains the phone connection. This request is ignored if the phone is inactive (on-hook); however, DECTalk returns an R3_PH_ONHOOK status reply. The command also disables the timeout function.

6.1.5 PH_STOPPAD

This command enables the telephone keypad, just like the PH_KEYPAD command, except that it also enables a special autostop mode. While in this mode, DECTalk simulates "stop speaking" and "disable speaking" commands before the key code (character) is sent to the host computer. DECTalk stops speaking as soon as possible; the pending speech is discarded.

2
Control sequences buffered in the communication channel between the host computer (user program) and DECTalk are processed, but no text will be spoken until DECTalk receives the "enable speaking" command. If a program uses phonemic mode, extra care should be taken to recover from a "disable speaking" command during phonemic text transmission.

don't say this under stop speaking
You can disable the autostop mode without disabling the keypad by sending a PH_KEYPAD sequence.

NOTE: The PH_STOPPAD command is ignored if DECTalk is operating as a level 1 device. (See Chapter 5.)

6.1.6 PH_TIMEOUT

This command starts (or restarts) an internal DECTalk timer. If the user does not press a telephone keypad button within the timeout interval, an R3_PH_TIMEOUT status is returned (Table 6-2).

The application program should set PH_KEYPAD on before sending a PH_TIMEOUT command; otherwise, the user cannot respond to DECTalk requests for input.

The parameter (P4) following PH_TIMEOUT is the timeout value, that is, the number of seconds to wait for a response from the caller. A parameter of 0 cancels any active timeouts. After a timeout, the timer is stopped. The application program must send a new PH_TIMEOUT command to restart the timer.

Timeouts are the only positive way to detect that the caller has hung up the telephone, although the wink detector can determine this earlier in many cases.

6.1.7 PH_TONE_DIAL and PH_PULSE_DIAL

DECTalk can dial an outgoing call by using these two commands. If DECTalk is connected to a Touch-Tone public telephone network, then use the PH_TONE_DIAL parameter; otherwise, use PH_PULSE_DIAL. PH_PULSE_DIAL works like a rotary phone dial.

If the telephone is on-hook when the host computer sends a dialing command, DECTalk picks up the telephone. If the first character of the dialing string is *not* a W, then the host computer inserts a standard 2-second delay.

The text between the command terminator z and the ESC \ sequence is the number to dial. For the Touch-Tone dialing system, the characters 0123456789*#ABCD!^WXTP are recognized. For the interrupted pulse dialing system, the characters 0123456789!^WXTP are recognized. (Also see Table A-4.)

The character ! inserts a 1-second delay into the dialing stream. DECTalk pauses during the dialing sequence every time it finds a ! character.

On some telephone systems, a user can press the switch hook to transfer calls or otherwise interrupt a phone call. This signal is called a switch-hook flash. The ^ character inserts a 0.25-second switch-hook flash signal into the dialing stream. You can use successive ^ characters to generate longer flashes.

CHAPTER 6

With Touch-Tone dialing, the characters ABCD generate the extra four tones of the military handset. A is the character to the right of the 3; B is the character below it, and so on.

The character T switches DECTalk to tone dialing mode; while the character P switches DECTalk to interrupted pulse dialing mode.

The character W is used to wait for dial tone. You can place a maximum waiting period value, in seconds, after the W by enclosing the number in < > characters. The W range is from 10 to 120 seconds. The following conditions apply.

1. If there is no < character after the W, then a 30-second default period is used.
2. If the user-specified time is less than 10 seconds, the W is set at 10 seconds.
3. If the user-specified time is greater than 120 seconds, the W is set at 120 seconds.
4. If a dial tone is detected during this waiting period, DECTalk proceeds with dialing. If a dial tone is not detected, the dialing sequence fails with a "bad dial tone" status.

The character X performs call progress detection. The maximum waiting time for call progress detection can be specified by a value placed between the < > characters (as in the W command).

The X default period is 30 seconds; the range is from 10 to 120 seconds.

6.1.8 PH_WINK

This command enables the wink detection feature. If a wink (a line current interruption) is detected on the line, a R3_PH_WINK status report is sent to the host computer. The command is ignored if the telephone is inactive (on-hook).

On *most* telephone exchanges, one or more winks will be generated when a caller hangs up on DECTalk. Winks can be used to clear a call. A timeout *must* also be used, to deal with situations where the wink is not available. The command is ignored if the DECTalk operates as a level 1 device. (See Chapter 5.)

The wink detector may see a false wink, caused by transients on the telephone line, if the wink detector is enabled immediately after the telephone is taken off-hook. The wink detector should be enabled a few seconds after pick-up. The easiest way to accomplish this is to enable the wink detector *after* the initial greeting message is spoken.

6.1.9 PH_NOWINK

This command disables the wink detection feature. It is ignored if the telephone is inactive (on-hook). The command is ignored if DECTalk operates as a level 1 device. (See Chapter 5.)

6.1.10 Examples of Telephone Communication Sessions

The following figures show typical communication sessions between a host computer and a user.

Figure 6-1 shows a phone call session, including a timeout sequence initiated because a user was disconnected.

Figure 6-2 is a successful dialout session with a user being connected to the host computer.

Figure 6-3 is a busyout session where the telephone is busy while the host computer is trying to call.

Figure 6-4 shows a dialout session where the telephone is not answered.

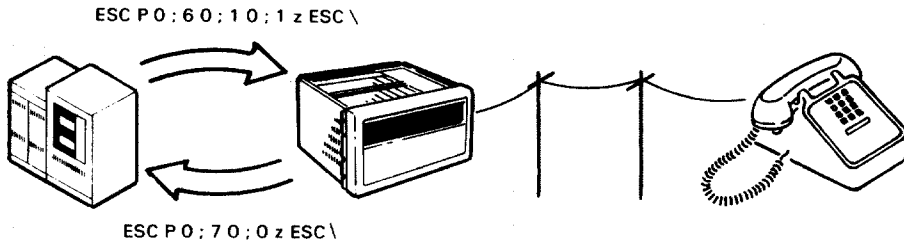

HOST COMPUTER ENABLES COMMUNICATION WITH DT__PHONE/PH__ANSWER.
DECTalk SENDS R3__PH__ONHOOK TO HOST COMPUTER.

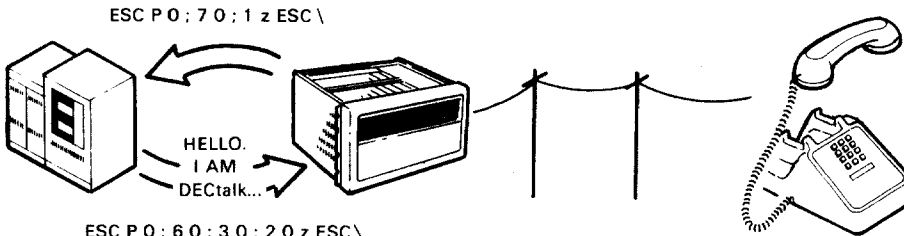

ESC P 0 ; 6 0 ; 3 0 ; 2 0 z ESC \

CALLER DIALS IN. DECTalk SENDS R3__PH__OFFHOOK TO HOST COMPUTER.
HOST COMPUTER ENABLES 20-SECOND TIMEOUT AND BEGINS COMMUNICATION CONTROL.

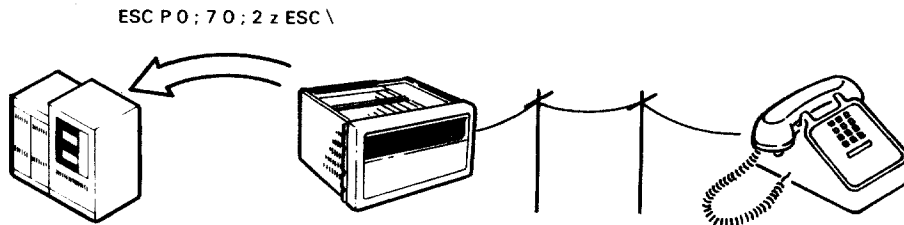

CASE 1: USER HANGS UP. AFTER NO SIGNAL IS RECEIVED FOR 20 SECONDS,
DECTalk SENDS R3__PH__TIMEOUT TO HOST COMPUTER.

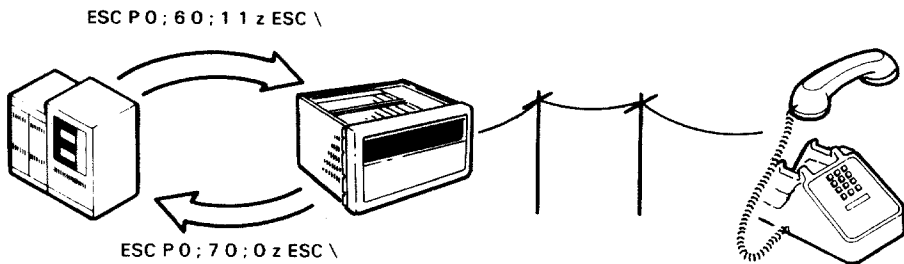

CASE 2: HOST COMPUTER TERMINATES SESSION AND SENDS PH__HANGUP.
DECTalk HANGS UP PHONE AND REPLIES WITH R3__PH__ONHOOK.

MA-0350-85

Figure 6-1 Phone Call Session with User Disconnect

TELEPHONE COMMUNICATIONS

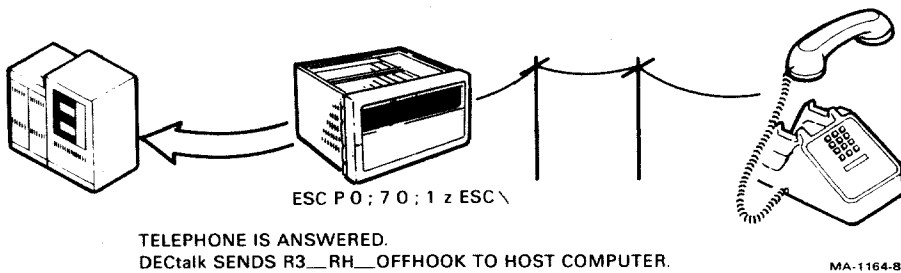
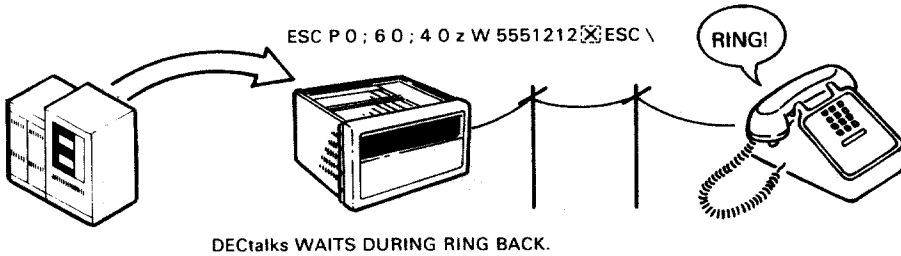
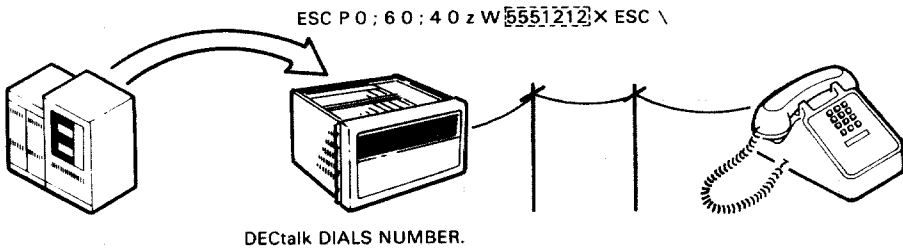
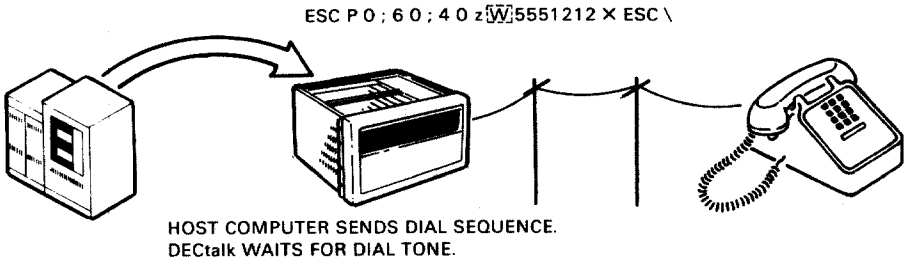

Figure 6-2 Successful Dialout Session

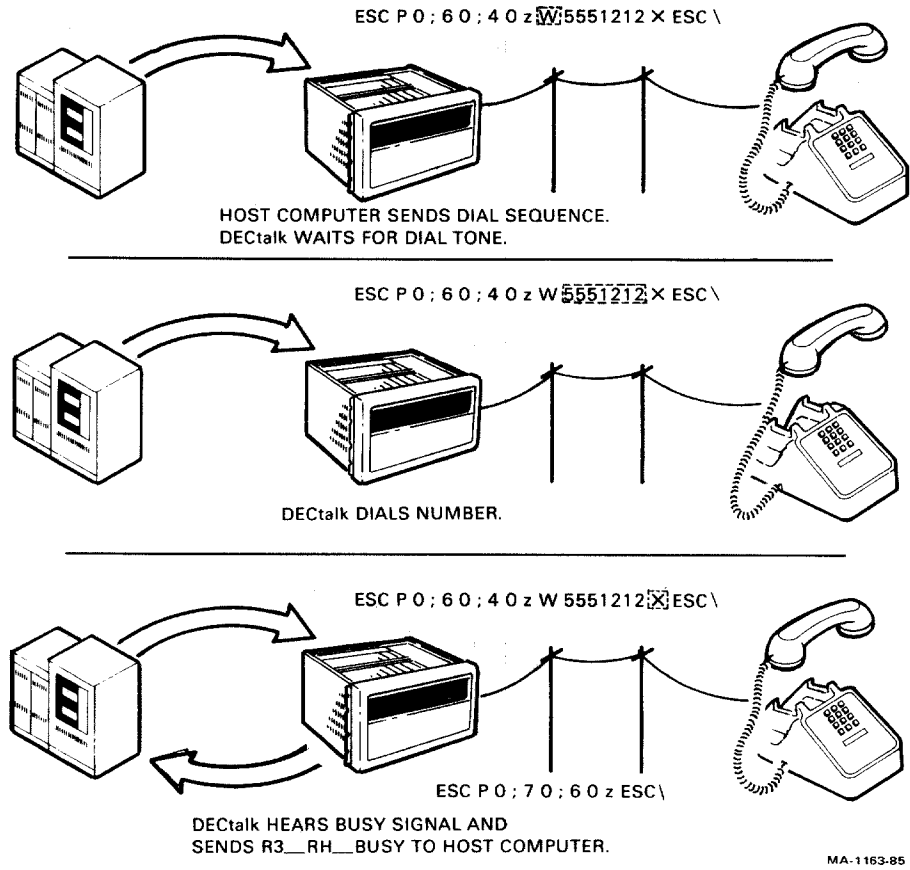
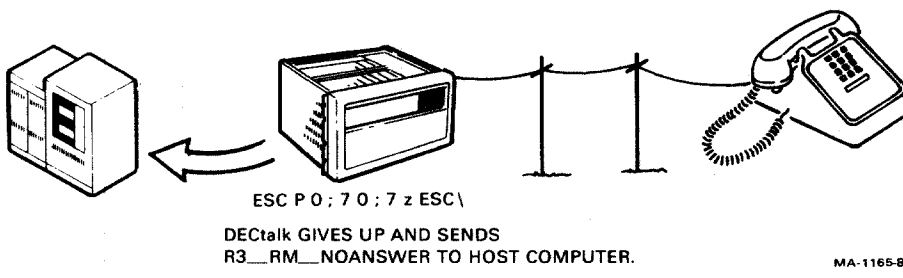
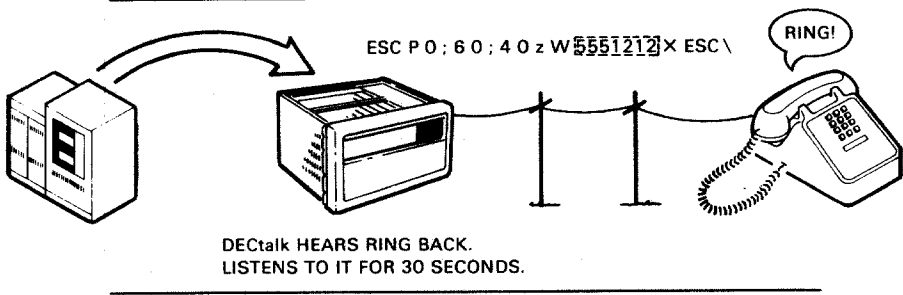
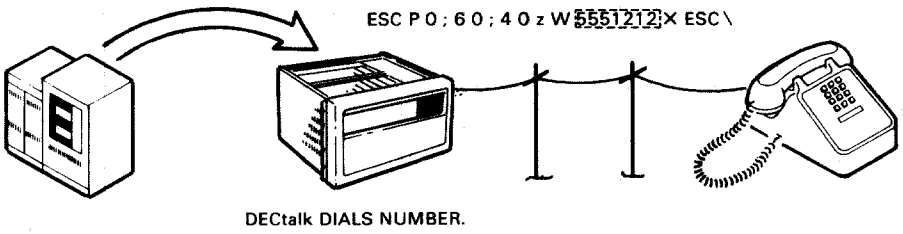
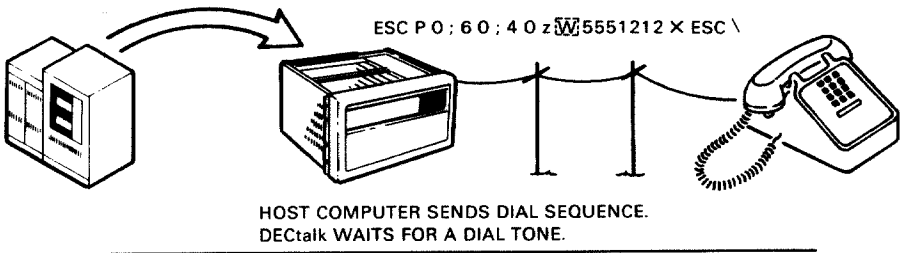

Figure 6-3 Busyout Session



MA-1165-85

Figure 6-4 No Answer Session

6.2 KEYPAD MASK (DT_MASK)

The DT_MASK command controls how DECtalk sends escape sequences and keypad characters to the host computer. This command allows DECtalk to add a carriage return to the end of its replies.

The command takes one parameter, which is interpreted as a value from the 16-bit keypad mask matrix (Table 6-3).

Table 6-3 DT_MASK Parameters

P3 parameter

Value	Bit	Character
1	0	0
2	1	1
4	2	2
8	3	3
16	4	4
32	5	5
64	6	6
128	7	7
256	8	8
512	9	9
1024	10	*
2048	11	#
4096	12	A
8192	13	B
16384	14	C
32768	15	D

P4 parameter

Value	Function
0	Assign mode.
1	Set bits.
2	clear bits.

If a bit is set, DECTalk sends a carriage return after sending the associated keypad character. If any bit is set, DECTalk sends a carriage return after its escape sequence replies. (The carriage return follows the ESC \ string terminator.) Many operating systems translate the carriage return to a carriage return and line feed. The DT_MASK escape sequence is as follows.

```
ESC P 0 ; 8 3 ; P3 ; P4 z ESC \
027 080 048 059 056 051 059 *** 059 *** 122 027 092
```

The P3 parameter is bit-encoded. Specified values have associated characters (Table 6-3). If you specify a value, DECTalk sends a carriage return after the associated character (when a user presses that key).

The P4 parameter is the level 2 device function. It controls the interpretation of the P3 parameter as follows.

If P4 is 0, then P3 is a new keypad mask.

If P4 is 1, then P3 is a bit set to be set in the keypad mask.

If P4 is 2, then P3 is a bit set to be cleared in the keypad mask.

For example, to have DECTalk treat the # and * characters as response terminators (but not the digits), a program would send the following sequence.

```
ESC P ; 8 3 ; 3 0 7 2 z ESC \
027 080 059 056 057 059 051 048 055 050 122 027 092
```

(3072 = 1024 + 2048)

If the person calling the application presses 123# followed by a keypad timeout, DECTalk would send the following.

1 2 3 # <carriage return>

```
ESC P ; 7 0 ; 2 z ESC \ <carriage return>
027 080 059 055 048 059 050 122 027 092
```

This allows the application program to use standard line-oriented input routines, rather than character-oriented routines. If you specify a P3 parameter = 0 with DT_MASK, DECtalk will not send a carriage return after keypad characters or escape sequences.

NOTE: DECtalk will send a carriage return after all sequences, including responses to non-DECtalk-specific sequences such as device status request.

At power-up, the keypad mask is set to all 0s or all 1s, depending on the position of DIP switch SW3 on the DECtalk module. (See Appendix B.)

DT_MASK simplifies application development when DECtalk is connected to a host computer via a packet-switched network or a network using the SNA (systems network architecture) protocol. These networks have a significant overhead associated with each message, so sending a line of text (several characters) is more economical than sending a single character.

DT_MASK is also useful when DECtalk is connected to an operating system that prefers to communicate line-by-line, rather than character-by-character. For example, when DT_MASK is on, you can use BASIC's INPUT LINE command to read text from DECtalk.

PART 3

DECtalk PHONEMICS AND VOICES

Chapter 7	DECtalk Phonemic Input	74
Chapter 8	Voice Commands and the User Dictionary	103
Chapter 9	Modifying the Voices	112
Chapter 10	How to Get the Most Out of DECtalk	136

7 DECtalk PHONEMIC INPUT

This chapter describes the phonemics (English sound system) used in DECtalk and the ways to control DECtalk's pronunciation.

7.1 PHONEMIC TRANSCRIPTION

Most users do not need to know anything about DECtalk phonemics input. However, to understand how the DECtalk system works and to make DECtalk correctly pronounce any English word, you need to know something about speech sounds and how to represent them on a keyboard. Because spelling in English does not always show exactly how words are pronounced, dictionaries use symbols to show how words really sound. Sometimes these symbols are the same as letters used in spelling. A word written the way it is pronounced is said to be written in *phonemic transcription*.

7.2 PRONUNCIATION ERRORS

When DECtalk says a word or phrase incorrectly, you may need to use phonemic input to get the desired pronunciation. The following list suggests the most common types of errors that DECtalk makes, and the best corrective action.

1. DECtalk mispronounces a proper name.

Lee Iacocca

Corrective action: Convert to phonemic form.

Lee [ayaxk'owkax]

Or misspell in a clever way.

2. DECTalk mispronounces an acronym.

The UN building

Corrective action: Respell with spaces between the letters.

U N

Or use phonemics.

[ˈyu ˈehn]

3. DECTalk mispronounces an unfamiliar word.

articulatory

Corrective action: Convert to phonemic form.

[aartˈihkyxaxlax ˈowriy]

4. DECTalk mishandles a letter string containing nonalphabetic characters.

sys\$system
vax750

Corrective action: Respell with inserted spaces.

sys \$ system
vax 7 50

Or convert to phonemic form.

[sˈihs dˈaalrrs ˈayn sˈihstaxm]
[vˈaeks sˈehven fˈihftiy]

5. DECtalk guesses wrong for an ambiguously pronounced word.

The insert
Get the lead out.

Corrective action: Request alternate pronunciation by using parenthesis notation.

The)insert
Get the)lead out.

Or convert to phonemic form.

The ['ihnsrɪt]
[g'eht dhax l'ehd`awt]

6. DECtalk uses the wrong syntactic classification of a preposition/particle.

He takes on tough jobs.
("He does tough jobs" versus "He accepts graft when on tough jobs.")

Corrective action: Add a stress phoneme when needed.

He takes [']on tough jobs.

Or convert to phonemic form.

He takes ['aan] tough jobs.

7. DECtalk uses the wrong phrasing.

Following a long gasp shouts were heard.

Corrective action: Add commas or verb-phrase introducer phonemes where needed.

Following a long gasp, shouts were heard.

7.3 INTRODUCTION TO PHONEMIC THEORY

At one time long ago, English was pronounced as it was spelled, with each letter (or pair of letters) representing one sound, or *phoneme*. Because of historical sound changes (such as the dropping of sounds like the “gh” of “bought”) and word borrowing from other languages, English pronunciation rules have become complex and include many exceptions.

For example, “of” is pronounced with a *v* sound, while all other English words spelled with “f” are pronounced with an *f* sound. The vowel digraph “ea” can be pronounced in at least a half-dozen ways, as illustrated by the sounds in the words “cheap,” “head,” “earth,” and “idea.” The letters “th” can be pronounced with a voiceless phoneme, as in “thin”; or with a voiced phoneme, as in “the”; or the “th” can represent the *t* phoneme followed by the *h* phoneme in compound words such as “pothole.”

Some words have two pronunciations, for example, “read.” Correct pronunciation of a sentence such as “Will you read the book or have you read it already?” requires an understanding of the meaning of the sentence – a task beyond DECTalk’s ability. Therefore, DECTalk speaks words with alternate pronunciations by choosing the more frequently used pronunciation.

You can get the alternate pronunciation in several ways.

- By misspelling the word: “red” for “read”
- By phonemic spelling: [r'ehd]
- By using the alternative pronunciation symbol [ʹ], as described in Section 7.6.10. For example, “He)read this book yesterday.”

Stress is an important part of phonemic representation. Stress alone distinguishes the two different pronunciations of words like “insert.”

English words usually have one syllable that is spoken with more stress than the other syllables in the word. You can indicate this primary stress to DECTalk by placing the phonemic symbol [ˈ] before the vowel. The [ˈ] symbol is described in Section 7.6.1.

For example, the word “insert” can be spoken as a noun

“insert” = [ˈɪnsɜrt]

and as a verb

“insert” = [ɪnˈsɜrt]

Considering the complexity of English pronunciation rules and the number of exceptions, it is not surprising that DECtalk sometimes makes pronunciation errors. You can adjust DECtalk’s pronunciation through a large number of symbols, described in the rest of this chapter.

7.4 PHONEMES

A phoneme is the smallest unit of speech that distinguishes one word from another. Of all the sounds that human beings can produce, relatively few are significant in any one language. Only about 40 different sound types (phonemes) are used in General American English.

The phonemes of English are not pronounced the same by every speaker. We all know people who pronounce some words differently from the way we do, yet we understand them. The differences may occur because we come from different parts of the country. Because of these variations, there is no such thing as a universal standard pronunciation of English. DECtalk attempts to mimic a midwestern (Northern Milwaukee) dialect.

Because DECtalk pronounces a phoneme in a standard rule-governed way, it is not possible to imitate all other English dialects (although you can approximate some dialectal differences by phonemic spelling).

The following sections describe the vowel and consonant phonemes, stress and syntactic symbols, and optional direct control of intonation or singing.

7.5 VOWEL AND CONSONANT PHONEMES

Linguists have identified about 17 vowel phonemes and 24 consonant phonemes for American English. Figure 7-1 shows the vowel phonemes and the positions of the tongue when making the vowel sounds. Tongue position (high versus low in the mouth, and front versus back of the mouth) correlates with the frequencies of the two lowest natural resonances of the vocal tract. The lowest resonance frequency, or first formant, is symbolized by F1 in the figure, and the second formant by F2. Consonant phonemes are shown at the bottom of Figure 7-1 with their places of major articulatory constrictions and the manners of forming the constrictions.

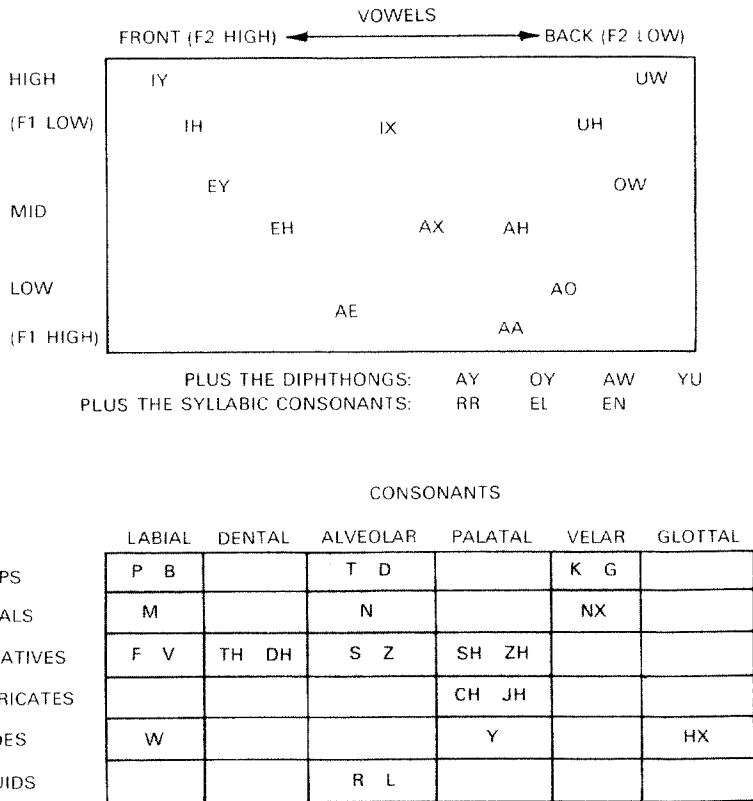

MA-7627-83

Figure 7-1 Phonemes Classified by Their Position in the Mouth Cavity

Table 7-1 lists the vowel phonemes and Table 7-2 lists the consonant phonemes. The DECTalk symbols used for each phoneme are identified by a key word with the relevant phonemic sound in *italic*.

Table 7-1 English Vowel Phonemes

Phonemic Symbol	Example	Phonemic Symbol	Example
Vowels			
aa	<i>father</i>	ih	<i>bit</i>
ae	<i>bat</i>	iy	<i>beat</i>
ah	<i>but</i>	ow	<i>boat</i>
ao	<i>bought</i>	oy	<i>boy</i>
aw	<i>bout</i>	rr	<i>bird</i>
ax	<i>about</i>	uh	<i>book</i>
ay	<i>bite</i>	uw	<i>boot</i>
eh	<i>bet</i>	yu	<i>cute</i>
ey	<i>bake</i>		
Allophone			
ix	<i>kisses</i>		
R-Colored Diphthongs			
ar	<i>bar</i>	or	<i>bore</i>
er	<i>bear</i>	ur	<i>poor</i>
ir	<i>beer</i>		
Syllabic Consonants			
el	<i>bottle</i>	rr	<i>butter</i>
en	<i>button</i>		

In many cases, phonemes are indicated by two letters, instead of special characters or diacritic symbols that often appear in dictionaries. DECtalk requires a case-insensitive representation (uppercase and lowercase are acceptable). The letter pairs have been designed so that it is not necessary to put a space between phonemes of a word. In fact, the space indicates word boundaries. DECtalk can parse input phonemic letter sequences to determine the unique phoneme sequence in all cases.

Phonemes are enclosed in square brackets instead of between the more traditional / symbol. The [and] characters mark the beginning and end of phonemic mode clearly with distinctively different symbols. The input format is not strictly phonemic because it also permits you to enter certain allophones (variants of a phoneme), making the representation closer to a broad phonetic transcription.

Table 7-2 English Consonant Phonemes and Allophones

Symbol	Phonemic Example	Symbol	Phonemic Example
Consonants			
b	<i>bin</i>	p	<i>pin</i>
ch	<i>chin</i>	r	<i>red</i>
d	<i>debt</i>	s	<i>sit</i>
dh	<i>this</i>	sh	<i>shin</i>
f	<i>fin</i>	t	<i>test</i>
g	<i>give</i>	th	<i>thin</i>
hx	<i>head</i>	v	<i>vest</i>
jh	<i>gin</i>	w	<i>west</i>
k	<i>cat</i>	yx	<i>yet</i>
l	<i>let</i>	z	<i>zoo</i>
m	<i>met</i>	zh	<i>measure</i>
n	<i>net</i>	—	(silence)
nx	<i>sing</i>		
Allophones			
dx	<i>rider, writer</i>	rx	<i>oration</i>
lx	<i>bell</i>	tx	<i>Latin</i>
q	<i>we eat</i> (glottal stop)	~	(rule-blocking phoneme)

7.5.1 Phonemic Correction the Easy Way

Most users will want to learn the phonemic code. However, you can also consult one of the dictionaries described in Appendix E to determine the phonemic pronunciation for a word that DECtalk gets wrong. You can convert the word to the DECtalk phonemic code by using the table in Appendix E.

For example, according to the Merriam-Webster Dictionary, the pronunciation of the word "Mozart" is

\`mot-,sart\`

Consulting Table E-1 of Appendix E, you can convert this transcription to the DECtalk phonemic string

[m'owtsaart]

7.5.2 Automatic Phonemic Substitution for a Mispronounced Word

Every time DECtalk mispronounces a word in running text, your host computer could be programmed to replace the text string ("Mozart") with a phonemic string ([m'owtsaart]).

However, if the number of words requiring phonemic translation in an application is small (under about 200), it might be simpler to download a user dictionary to DECtalk and let DECtalk perform the replacement automatically. A sample user dictionary is shown below.

Letters	Phonemes
Mozart	m'owtsaart
logo	l'aog`awt

You can download the dictionary to DECtalk with the following commands.

```
ESC P 0 ; 4 0 ; z Mozart m'owtsaart ESC \
ESC P 0 ; 4 0 ; z logo l'aog`awt ESC \
```

NOTE: Keep your user dictionary as a file on the host computer because the dictionary must be downloaded every time you power up DECtalk. For more information on user dictionary creation and downloading procedures, see Section 8.9.

The white spaces between the components of this command are there for clarity. Do not type spaces in your actual command, except at the position indicating the separation between the word and its phonemic representation. Once downloaded, the dictionary overrides the standard DECtalk dictionary or letter-to-sound rules that would otherwise handle these words.

DECtalk will speak the plural form of a word in the user dictionary by stripping off the "s" and consulting the dictionary for a match to the remaining root. Similarly, DECtalk will remove many common suffixes such as "-ing" and "-ed" by rule and compare the root with entries in the user dictionary. With this function, you do not need to place all of the derived forms of words in the user dictionary.

You should be aware of some pitfalls when using the dictionary. Placing a word in the dictionary could cause a similar word to be mispronounced. For example, if you place "on" in the dictionary, DECtalk might decompose a word such as "only" as "on" plus "-ly," and mispronounce the word. The only way to correct this problem is to add "only" to the user dictionary. It is difficult to foresee these cases, but they are relatively rare.

7.5.3 Vowels

The vowel phonemes of English are listed in Table 7-1. While DECtalk recognizes 17 vowel phonemes, these vowels can sometimes change slightly when surrounded by certain phonemes. These variants are discussed in Section 7.5.4.

7.5.4 Vowel Allophones

The variants of a phoneme are called *allophones*. For example, a vowel such as the [iy] in "beat" sounds slightly different when followed by [r] as in "beer." Sections 7.5.4.1 through 7.5.4.3 describe some allophones.

7.5.4.1 Allophones for R-Colored Vowels – The vowels in words such as “beer,” “bear,” “bar,” “bore,” and “poor” are different from the available vowel phonemes in DECtalk. They require special vowel-r allophones, which are listed in Table 7-1.

7.5.4.2 Schwa Allophone – Another problem is with the unstressed reduced vowel called “schwa” in English. The vowel appears in words such as “about” and “kisses.” In “kisses,” the vowel is produced with a higher tongue position, symbolized by the vowel allophone [ix] in Table 7-1. You can choose between [ax] and [ix] by noting the characteristics of the adjacent phonemes, but listening to the words will result in the best choice.

7.5.4.3 Syllabic Consonants – The final syllable in words such as “butter,” “bottle,” and “button” is usually symbolized in a dictionary as consisting of a short vowel followed by a consonant. For better sounding synthesis, DECtalk uses a set of syllabic consonants, [rr], [el], and [en] of Table 7-1, that are realized without the short schwa. Syllabic “r” shares the same symbol as the phoneme [rr] in a word such as “bird,” but this leads to no confusion inside DECtalk.

The [əm] allophone used in an earlier version of DECtalk no longer exists and must be replaced by the two-phoneme sequence [axm] as in the word “bottom” = [b'aataxm].

In most situations, you do not need to be concerned about allophones because the vowel phonemes in Table 7-1 will be automatically converted into the appropriate allophones by DECtalk rules. For the sophisticated user, allophone selection can be induced or blocked by using the syllable boundary phoneme [-] and the rule-blocking phoneme [~] (Sections 7.6.7 and 7.5.6.6), or by inserting allophone symbols in the phonemic spelling.

7.5.5 Consonants

The symbols that represent consonants are straightforward (Table 7-2). In two cases, [hx] and [yx], the two-letter sequence ensures unambiguous parsing because the letters “h” and “y” are parts of some vowel symbols.

DECtalk speaks an English dialect that does not distinguish between voiced and voiceless w, so words like “which” and “witch” are pronounced alike as [w'ihch].

The letter “g” can be pronounced in two ways. In words like “gift,” the consonant phoneme [g] is used. In words like “gin,” the phoneme [jh] is used.

The letter sequence “th” can be pronounced with a voiceless sound [th] as in “thin” or with a voiced sound [dh] as in “this.”

The [y] phoneme used in an earlier version of DECtalk has been replaced by the [yx] phoneme (as in the word “yet” = [yx'eht]).

7.5.6 Consonant Allophones

The consonants [t], [d], [r], and [l] may be replaced by special allophones under certain conditions. These allophones are listed in Table 7-2.

7.5.6.1 Dental Flap – The [t] and [d] phonemes are often replaced by a very brief tongue flap allophone [dx] when the consonant phoneme appears between two vowels and the second vowel is unstressed. DECtalk rules insert this allophone in appropriate situations.

7.5.6.2 Glottal-T – The [t] phoneme may be replaced by a glottalized [tx] allophone, especially in word-final position if the next word begins with a sonorant consonant. DECtalk rules insert the allophone where appropriate.

7.5.6.3 Postvocalic-R – The [r] that appears after a vowel is not as constricted as a word-initial [r]. DECtalk automatically selects this somewhat velarized allophone [rx] or an r-colored diphthong where appropriate.

7.5.6.4 Postvocalic-L – The [l] that appears after a vowel may sound different from the [l] in other contexts. For some speakers, the tongue tip may not even reach the roof of the mouth. This postvocalic allophone [l_x] is automatically selected by DECtalk.

7.5.6.5 Glottal Stop – The glottal stop [q] is used in some situations to indicate a word boundary, especially when the next word begins with a vowel. Overuse of this symbol can lead to a stilted style of speaking.

7.5.6.6 Controlling Allophone Selection – DECtalk automatically inserts certain other allophones for [k], [q], and [nx] when appropriate. DECtalk also selects the prevoiced and voiceless unaspirated allophones of [b], [d], and [g]. You cannot access these allophones.

If DECtalk does not select one of the allophones of Table 7-2, you can insert the allophone symbol directly in a phonemic representation of the word in question.

If DECtalk uses one of these allophones inappropriately, place the rule-blocking phoneme [~] before the phoneme in question to block application of all allophonic substitution rules. For example, to say “batter” without a flap being substituted for the [t], enter the phonemic string [b'ae~trr].

7.5.7 Silence Phoneme [–]

DECtalk automatically inserts a silence (brief pause) whenever punctuation appears in the text. The phonemic silence symbol [–] is useful for controlling silence while in phonemic mode. Silences and other pauses are described in more detail in Section 7.7.1.

7.6 STRESS AND SYNTACTIC SYMBOLS

Correct speech is more than simply stringing together a series of words or phonemes. The meaning of a sentence is carried by the words, plus rhythm, stress, and intonation (pitch change). You recognize a question by the rising intonation of the voice, while a statement is usually accompanied by falling intonation. A speaker can give certain words in a sentence more importance by adding stress (loudness and length) to them. Pitch often reveals the emotional state of the speaker. For effective communication, you need to consider these expressive features as well as the segmental features of speech.

As any good actor knows, punctuation alone is not enough to indicate the full meaning of a sentence. Some fine points of expression cannot be indicated by using phonemic symbols. Full control of the expression of a sentence is gained by directly changing the duration and pitch of words and phrases. These direct control techniques are discussed in Section 7.7.1.

DECtalk uses stress and syntactic symbols to control aspects of rhythm, stress, and intonation patterns. These symbols include punctuation marks such as commas, periods, and exclamation marks. Punctuation marks are recognized by DECtalk as indicating special phrasing requirements. The following sections and Table 7-3 show how to improve the phrases in DECtalk speech.

Table 7-3 Stress and Syntactic Symbols

Symbol	Function
Stress Symbols	
'	Primary stress
˘	Secondary stress
ˆ	Emphatic stress
/	Pitch rise
\	Pitch fall
/\	Pitch rise and fall
Syntactic Symbols	
Space, tab, carriage return	Word boundary
-	Syllable boundary
*	Morpheme boundary
#	Compound noun
(Beginning of prepositional phrase
)	Beginning of verb phrase
,	Clause boundary
.	End of sentence
?	End of question
!	End of exclamation
+	New paragraph

7.6.1 Primary Stress [']

All content words of English (nouns, verbs, adjectives, and adverbs) contain one primary stressed syllable. DECTalk represents primary stress on a syllable with an apostrophe ['] placed before the stressed vowel phoneme of the word as in the following example.

[bahtrr].
(No stress, flat intonation, too rapid.)

[baht'rr].
(Stress on wrong syllable – “butter.”)

[b'ahtrr].
(Correct stress – “butter.”)

You can also place the primary stress symbol between words, in which case it modifies the next word. For example, in the sentence “He rang up the sale,” DECTalk treats “up” as a preposition (without stress) instead of a particle. “Up” is correctly stressed if you write the sentence as

He rang [']up the sale.

NOTE: There can be no space between a stress and syntactic phoneme (for example, [']) and the following word.

7.6.2 Secondary Stress [`]

Use the secondary stress symbol [`] to indicate a degree of stress that is between primary stress and unstressed. Secondary stress is appropriate in the following cases.

- To highlight the next strongest syllable of polysyllabic words, such as “demonstration.”

[d `ehmaxnstr'eyshaxn].

- On second parts of compound nouns, as in “pushover.”

[p'uhs# `owvrr].

- In some pronouns, such as “I” and “we.”

DECtalk realizes secondary stress by lengthening the vowel sound more than unstressed (but less than primary stress). A pitch rise may also occur on an early secondary stress. In most cases, you can leave out the secondary stress symbol.

7.6.3 Emphatic Stress [']

You can place the emphatic stress symbol ['] before any vowel to give emphasis to that syllable of the word. Good readers of English text understand the message of the sentence well enough to pick out the most important word and emphasize it. DECtalk merely pronounces words; it does not understand the sentences it is saying. DECtalk cannot place emphasis on words to give a completely different meaning to the sentence unless you use the emphatic stress symbol. Here is an example.

Dennis loves Mary.
(Usual neutral pronunciation.)

[d'ehnihs] loves Mary or ['] Dennis loves Mary.
(*Dennis* – not Frank – loves Mary.)

Dennis loves [m'ehriy] or Dennis loves [']Mary.
(Dennis loves *Mary* – not Jill.)

The exclamation point has the similar effect on the final stress of a sentence.

Help!

7.6.4 Unstressed Syllables

The English language contains a set of words that are always unstressed, called *syntactic function* words. This set includes the following words.

Prepositions (for, over)
Conjunctions (and, but)
Determiners (the, some)
Auxiliary verbs (is, has)
Pronouns (her, myself)
Clause introducers (which, that)

These words have no stress symbols in their dictionary entries. It is sometimes necessary to emphasize a function word that is stored in DECtalk's dictionary without stress. You can do this by including a primary stress symbol or an emphatic stress symbol in the phonemic transcription as in the following example.

He went ['owvrr] the fence, not under it.

or

He went [']over the fence, not under it.

7.6.5 Pitch Control [/], [\], [/\]

DECtalk contains built-in rules to determine the pitch contour of a sentence. While these rules are correct most of the time, you can override them by placing the pitch rise [/], pitch fall [\], and pitch rise and fall [/\] symbols before selected words (or vowels if you want finer control).

The [/] and [\] symbols must alternate, and the first symbol must be a rise. Note that you can place both a rise and a fall on the same syllable by using [/\]. You can hear the difference by trying the following two sentences.

It's a mad mad mad mad world.

It's a [/]mad [\]mad [/]mad [\]mad [/\]world.

7.6.6 Word Boundary

Any whitespace character (space, tab, or carriage return) in the text indicates a word boundary. DECtalk uses word boundary symbols to select the word-beginning or word-ending allophone of a phoneme.

Some host computers automatically insert a carriage return into lines that are too long (and would go off the edge of the screen or paper). This may cause DECtalk to pronounce text incorrectly if a carriage return occurs in the middle of a word. You can prevent this problem by breaking long sentences with a carriage return at an appropriate place.

7.6.7 Syllable Boundary [-]

DECtalk uses a set of rules to determine where words break into syllables, so consonants within words are assigned to their correct syllable. Use the syllable boundary symbol [-] to tell DECtalk where to assign the consonants within ambiguous words. (This type of error rarely happens in DECtalk).

Example: oration

[ow-r'eyshaxn] (DECtalk made an incorrect guess.)

[ow-r'eyshaxn] (Correct.)

7.6.8 Morpheme Boundary [*]

English words are made up of meaningful units called *morphemes*. For example, "spell" has only one morpheme, while "misspelling" is made up of three: "mis," "spell," and "ing."

In most cases, the pronunciation of a word does not depend on morpheme boundaries. There are exceptions, however, in which case the morpheme boundary symbol [*] can be used to force the correct pronunciation. For example, "misspelling" should be pronounced with a double "s." Adding the morpheme boundary symbol improves the pronunciation of the word.

misspelling.

mixsp'ehlixnx (text to phoneme translation by DECtalk).
(The single "s" is too short.)

[mixs*sp'ehlixnx]
(Better.)

7.6.9 Compound Noun [#]

Compound words, such as "rush-hour," should be spoken with less stress on the second word. Also, words that were once compounds, such as "sideache," require decomposition for correct pronunciation.

DECtalk's dictionary includes an extensive list of compound words. You can use the compound noun symbol [#] to correct compounds that are not in the dictionary. For example, for "sideache," type the following phonemic transcription.

[s'ayd#`eyk].

Using a hyphen in compound words, for example, "rush-hour traffic," produces the correct pronunciation most of the time. You rarely need the [*] and [#] phoneme symbols.

7.6.10 Beginning of Verb Phrase [)]

Moderately long declarative sentences are usually spoken as if they contain two units: a noun phrase and a verb phrase. There is no pause between these two phrases, but there is a slowing down at the boundary, and the pitch tends to fall and then rise. DECTalk searches for this syntactic boundary to change pitch. However, the rarity or ambiguity of some verbs can cause confusion.

The old man in the chair was rocking slowly.
(Correct verb phrase detected.)

The old man in the chair sat rocking slowly.
(Verb phrase not detected; pure mechanical analysis of the sentence does not show where "sat" belongs.)

The old man in the chair [)s'aet] rocking slowly.
(Phonemic correction.)

The right parenthesis [)] symbol is useful where a separation is needed between phrases but a comma is too strong. For example, you can use [)] to indicate a dangling prepositional phrase.

She hit the man with the umbrella.
(The man carries the umbrella.)

She hit the man [)] with the umbrella.
(She uses the umbrella.)

The [)] symbol has a second function: it can indicate alternate pronunciations of homographs. Homographs are words that are spelled the same but pronounced differently. For example, the word "insert" is either a noun or a verb. As a noun, it is pronounced [ihnsrɪt] and as a verb it is pronounced [ihns'ɪrɪt].

DECTalk typically defaults to the more frequent pronunciation. If DECTalk pronounces "insert" as a verb, and you need the other pronunciation, simply place the) symbol in front of the word.

The experienced secretary inserts more)inserts per hour.

Appendix D lists the pairs of common homographs that DECTalk knows.

7.6.11 Clause Boundary [,]

When a sentence is composed of more than one clause, it should be spoken in such a way that the listener can easily separate the sentence into its component clauses. The comma [,] is the symbol used to indicate clause boundaries. An orthographic comma and a phonemic comma have identical impact on the acoustic realization of a sentence.

Inserting a comma improves the quality of spoken sentences in the following cases.

- After an introductory prepositional phrase:

In particular cars cause pollution.
(Poor phrasing.)

In particular, cars cause pollution.
(Correct.)

- Around a parenthetical remark:

A picture it seems is worth . . .
(Poor phrasing.)

A picture, it seems, is worth . . .
(Correct.)

- In a list of more than two items:

They ate apples oranges and bananas.
(Poor phrasing.)

They ate apples, oranges and bananas.
(Correct.)

7.6.12 Period [.]

A sentence is usually a single, complete thought. It is also the longest utterance that you can comfortably speak in one breath. DECtalk inserts a pause when it finds a period that marks the end of the sentence, duplicating the human speaker's pause to take a breath.

The [.] symbol also tells DECtalk that a complete sentence has been sent and it is safe to begin speaking. DECtalk will not speak a phrase until it finds a comma or sentence terminator. After a few seconds, text sent to DECtalk is spoken even if no comma has been received. DECtalk also tests each period to make sure it is not part of a known abbreviation.

7.6.13 Question Mark [?]

The simplest way to indicate a question in English is by a rising tone at the end of a sentence, although true question intonation is not that simple and depends on the meaning of the question.

There are many cases in English where a question (rising) intonation is not appropriate, even though the sentence ends with a question mark.

- Rhetorical questions or quotations may contain a question mark, but the speaker ends with a period (falling tone).
- Sentences that begin with "wh" words ("who," "what") usually end with a falling tone, even if they are questions.

Although DECtalk is smart enough to recognize "wh" questions and speak them correctly, you should send question marks to DECtalk only when the sentence really is a question. Here are some examples.

Laura ate her broccoli?
(DECtalk asks a question.)

What time is it?
(DECtalk recognizes "wh" and does not rise at the end).

7.6.14 Exclamation Point [!]

Exclamations are short statements spoken with special emphasis. DECtalk interprets an exclamation point to mean that the last stressed syllable in the sentence should have extra emphasis.

Stop!

Long sentences ending with an exclamation point typically have a single word that receives extra stress. DECtalk has no way of knowing which word to stress and chooses the last word by default. Use the emphatic stress symbol ['] to emphasize a different word when the last word is not appropriate.

Joan won the marathon!
(DECtalk emphasizes the last word.)

['] Joan won the marathon.
(Correct.)

7.6.15 New Paragraph [+]

The new paragraph phoneme [+] should be inserted in text wherever a text preprocessor thinks that a new paragraph has begun. (DECtalk does not do this automatically because there is no standard new paragraph indicator in general text – the tab is used in too many other ways.)

The new paragraph phoneme [+] modifies the intonation contour and adds variety to running text. The first sentence of a new paragraph is produced with a higher, more lively fundamental frequency. DECtalk will also pause longer between paragraphs to give the listener an indication of a change of topic.

[+] This paragraph has the [+] phoneme inserted in the appropriate place. The new paragraph symbol can be used in other situations, such as to help indicate the start of a new mail message in a list of mail messages.

7.7 DIRECT CONTROL OF DURATION AND PITCH

Displaying the correct emotion through voice alone is a difficult task, as any radio actor will tell you. The best method is to experiment with phonemic symbols until you achieve the quality you want. Emotional content is usually connected to the sentence content, so varying both together is the best way to convey feelings.

For example, you can have DECTalk say a simple phrase like "Good morning" in several different ways.

Good morning.
(Normal tone.)

Good morning!
(Emphatic.)

Good morning?
(Questioning.)

[g''uhd] morning.
(Emphasize "good.")

If these alternatives do not produce what you need, you can use direct prosodic control. You must represent the entire sentence phonemically, specifying a duration for each phoneme that does not match the natural model. You should also give some or all phonemes specific target pitch values. DECTalk will compute smooth transitions between pitch values, where the specified pitch is reached at the end of the phoneme.

7.7.1 Duration and Pitch [$\langle \rangle$]

DECTalk uses angle brackets [$\langle \rangle$] to enclose duration and pitch values of phonemes.

The format is

\langle duration,pitch \rangle

where duration is the length of the phoneme in milliseconds (ms) and pitch is the fundamental frequency of the phoneme in hertz (Hz).

Any phoneme may be followed by angle brackets to alter the default duration and pitch. If either value is omitted, or specified as 0, the default value is used. The values for duration and pitch are separated by commas.

[ow]
(Normal phonemic specification.)

[ow<1000>]
(1,000 ms duration.)

[ow<,90>]
(Default duration, 90 Hz pitch at end.)

[ow<1000,90>]
(1,000 ms duration, 90 Hz pitch at end.)

For example, to say "Oh?" with a greater degree of skepticism than DECtalk normally imparts, you could type

[_<,90>ow<400,150>].

The [ow] phoneme begins at 90 Hz and ends (after 400 ms) at 150 Hz.

Note the use of the silence symbol [_] in the example just given. Pitch and duration values must always be attached to a preceding phoneme. The silence symbol is used so that the value (90 Hz in this example) is applied to the beginning tone of the next spoken phoneme [ow].

Many of the phonemes in Tables 7-1 and 7-2 (all except the stop consonants p, t, k, b, d, and g) can be sustained in a monotone for an arbitrarily long duration by using direct prosodic control. For example, to sustain "ah" for a duration of 10 seconds (10000 ms) at a pitch of 120 Hz, type

[_<,120>ah<10000,120>].
(Produces "ahhhhhh . . .")

To produce a prolonged sigh, type

[_<100,150>ah<2500,80>].

where the silence phoneme causes the pitch contour to start at 150 Hz at the beginning of the "ah" and end at 80 Hz at the end of the "ah."

7.7.2 Singing

Singing uses different voice control techniques than conversation. Even untrained singers add liveliness to the sung notes by varying the pitch slightly, a quality called *vibrato*. Singing in DECtalk sounds mechanical without vibrato.

Each word or syllable is defined phonemically. The first number following a phoneme is the duration in milliseconds, and the second number is the pitch in hertz. Vowels and consonants not assigned a pitch remain at the same pitch as preceding segments. You can intersperse silence phonemes if you wish.

DECtalk stays exactly on pitch when the pitch is specified in hertz. You can add vibrato (to give a more realistic singing quality) by specifying notes with pitch values from 1 to 37. Note 1 is C2 and 37 is C5 on an equal tempered scale (A4 = 440 Hz) as shown in Table 7-4. C2 is the second C below middle C on a piano, C4 is middle C, and so on.

When notes are specified, DECtalk reaches the desired pitch within about 100 ms after the start of the phoneme and adds vibrato after changing to this pitch. When you give a specific nonsung pitch, DECtalk reaches the pitch target at the very end of the phoneme with no vibrato. The following example makes DECtalk “sing” the first four notes of Beethoven’s Fifth Symphony.

```
[d<100,17>aa<400> d<100,17>aa<400>]
[d<100,17>aa<400> d<120,13>aa<700>].
```

Table 7-4 Tone Values

Value	Pitch Note	Hertz	Voice Range				
1	C2	65.4					
2	C#	69.3					
3	D	73.4					
4	D#	77.8					
5	E	82.4	B				
6	F	87.3	A				
7	F#	92.5	S				
8	G	98.0	S	B			
9	G#	103.9		A			
10	A	110.0		R			
11	A#	116.5		I			
12	B	123.5		T			
13	C3	130.9		O			
14	C#	138.6		N	T		
15	D	146.9		E	E		
16	D#	155.6			R		
17	E	164.9			O		
18	F	174.7				A	
19	F#	185.0				L	
20	G	196.1				T	
21	G#	207.7				O	
22	A	220.0					
23	A#	233.1					
24	B	247.0					S
25	C4	261.7					O
26	C#	277.2					P
27	D	293.8					R
28	D#	311.2					A
29	E	329.8					N
30	F	348.9					O
31	F#	370.1					
32	G	392.2					
33	G#	415.5					
34	A	440.0					
35	A#	466.2					
36	B	494.0					
37	C5	523.4					

NOTE: C4 is middle C.

7.8 SELECTED READINGS

If you want to learn more about phonemics, acoustic phonetics, and speech synthesis, the following references are suggested.

The *Voice and Articulation Drillbook* by G. Fairbanks, second edition, (Harper and Row, 1960) is intended for speech therapists. This book includes an introduction to phonetics and acoustics. One of its diagnostic tests, the amplifier passage (p. 114), was used to adjust DECtalk's speech rate parameters.

The linguist responsible for DECtalk describes its operation in "The Klattalk Text-to-Speech System." This article by D. H. Klatt comes from the 1982 proceedings of the International Conference on Acoustics, Speech, and Signal Processing (IEEE Catalog No. 82CH1746-7, pp. 1589-1592).

The *Journal of the Acoustical Society of America*, Volume 67, (pp. 971-995) has an article by D. H. Klatt. The article, "Software for a Cascade/Paralleled Formant Synthesizer," describes the speech synthesizer that is the model for the one used in DECtalk.

For information on several speech synthesis technologies, read "Review of the Science and Technology of Speech Synthesis" by D. H. Klatt. This article comes from the proceedings of the 1981 Meeting of the National Academy Press in Washington, D.C., *Overviews of Emerging Research Techniques in Hearing, Bioacoustics, and Biomechanics* (pp. 15-33). (See also *Speech Group Working Papers*, MIT Research Laboratory of Electronics, Volume III.)

VOICE COMMANDS AND THE USER DICTIONARY

8

You can modify the DECtalk voices by using phonemic commands and the phonemic alphabet. This chapter describes a series of escape sequences that gives a host computer slightly greater control over DECtalk. For example, escape sequences can turn the DECtalk voice on or off and load the user dictionary.

8.1 SPEECH CONTROL

There are three ways to control DECtalk speech.

1. *Through English text* (sentences in standard English format and spelling). DECtalk speaks this text as written.
2. *Through phonemic spelling* (sentences or phrases written in phonemic symbols). Phonemic spelling is closer to the actual pronunciation of the text.
3. *Through phonemic commands*. Phonemic commands control features of speech that are not obvious from the visible text, such as rate of speech, sex of the speaker, and excitement level.

8.2 SPEECH TIMEOUT

Usually, DECtalk does not begin speaking until the host computer sends a clause terminator (period, comma, exclamation point, or question mark); however, there is a 5-second timeout limit. If the host computer does not send data within 5 seconds, DECtalk speaks the pending text in its input buffer, as if a VT (011) character had been sent.

Programs with long interruptions (such as pauses to search a data base) should collect complete sentences before sending anything to DECtalk. Otherwise, this timeout may cause unnatural breaks in sentences and jerky-sounding speech.

8.3 ENGLISH TEXT

DECtalk speaks sentences written in standard English, if the text follows three rules.

1. Sentences end with a period, exclamation point, or question mark.
2. All commas, periods, exclamation points, and question marks are followed by a space (or an equivalent character from Table 3-1).
3. A period must be followed by enough text to distinguish between abbreviations and the end of a sentence.

The host computer can send English text in paragraph format; that is, sentences can be broken in the middle by carriage returns.

If a sentence is too long to store in DECtalk's buffers, the sentence is spoken in sections. DECtalk breaks up the sentence and speaks it as if clause boundaries were present. The effect is similar to a person trying to speak a long sentence and running out of breath. Keep sentences down to a reasonable length or insert commas to avoid this effect.

Chapters 7, 10, and Appendix C provide more information on speech phrasing and emphasis. Section 8.6 in this chapter also describes how to coordinate speech and interaction commands to prevent loss of information.

8.4 SPEAK PHONEMIC TEXT (DT_PHOTEXT)

When `MODE_SQUARE` is on, you can enter the phonemic mode and embed phonemic text in normal text by using the square brackets. When sending data from the host computer, you can enter the phonemic mode by using the `DT_PHOTEXT` escape sequence as well as the square brackets; `MODE_SQUARE` does not have to be on. The `DT_PHOTEXT` escape sequence is as follows.

```
ESC P 0 ; 0 z text ESC \
027 080 048 059 048 122 **** 027 092
```

`ESC P 0 ; 0 z` is the same as a left bracket ([), and `ESC \` is the same as a right bracket (]). DECtalk uses phonetic speech for all text between the command terminator `z` and sequence terminator `ESC \`.

Appendix E of this manual lists the phonemic alphabet used by DECtalk.

In addition to sending the correct pronunciation, phonemic text can send control phonemes. This example changes the speech rate to 250 words per minute.

```
ESC P 0 ; 0 z :ra250 ESC \
```

8.5 STOP SPEAKING (DT_STOP)

This escape sequence immediately stops speech, even if DECtalk is in the middle of a sentence. Any pending but unspoken text is lost, including index markers that may have been sent by the host computer.

The `DT_STOP` escape sequence is as follows.

```
ESC P 0 ; 1 0 z ESC \
027 080 048 059 049 048 122 027 092
```

The stop sequence acts as a clause boundary. Speech stops immediately and all internal buffers are reinitialized.

8.6 DATA SYNCHRONIZATION (DT_SYNC)

The application program can send data to DECtalk faster than DECtalk can speak it. If the user must carry on a dialogue with the application program (through the telephone keypad), the application program should know whether DECtalk has finished speaking the text sent to it. DT_SYNC provides this coordination between the application program and DECtalk speech.

When the host computer sends DT_SYNC, DECtalk finishes speaking any pending text before processing the next command from the host computer. Therefore, the user hears a message before any other action starts, such as hanging up the telephone or starting the telephone timeout clock. Note that DT_SYNC acts as a clause boundary, the same as a comma, period, exclamation point, or question mark.

The DT_SYNC escape sequence is as follows.

```
ESC P 0 ; 1 1 z ESC \
027 080 048 059 049 049 122 027 092
```

DT_SYNC does not reply to the host computer when processing is complete. However, you can arrange to get a reply by following the DT_SYNC command with a DT_INDEX_QUERY command.

8.7 ENABLE OR DISABLE SPEAKING (DT_SPEAK)

The DT_STOP sequence stops speech in progress. The DT_SPEAK sequence turns speech processing off or on, so received text is either spoken or discarded. DT_SPEAK is useful if the host computer can recognize such things as electronic mail letterheads. The host computer can act as a filter, removing extraneous speech.

The DT_SPEAK escape sequence is as follows.

```
ESC P 0 ; 1 2 ; P3 z ESC \
027 080 048 059 049 050 059 *** 122 027 092
```

If P3 is 0, DECtalk stops speaking text; that is, it stops passing characters received from the host computer to the text-to-speech processing section. If P3 is not 0, DECtalk resumes speaking.

DECtalk also resumes speaking if the host computer sends DT_SYNC, DT_STOP, RIS, DECSTR, or any telephone command (for example, DT_PHONE:PH_ANSWER).

8.8 INDEXING

Text sent to DECtalk can contain index marks. DECtalk remembers these marks when they are spoken. The host application can listen to the spoken text (by reading the value of the last index) to determine how much transmitted text was actually spoken. Index markers are truly marks; they do not modify heuristics.

The following paragraphs describe how to mark text and return their values to the application program.

8.8.1 Index Text (DT_INDEX)

The DT_INDEX sequence inserts an index marker (flag) in the text stream sent to DECtalk.

```
ESC P 0 ; 2 0 ; P3 z ESC \
027 080 048 059 050 048 059 *** 122 027 092
```

The P3 parameter may range from 0 to 32767, sent as the ASCII characters for the number. Numbers outside the range are brought into range by unconditionally masking off any high order bits.

For example, the host computer sends the following data stream to DECtalk and marks the first variable with the index 15.

```
Hello ESC P 0 ; 2 0 ; 1 5 z ESC \ there.
```

After speaking the text before DT_INDEX, DECtalk remembers the value 15. The host computer may use DT_INDEX_QUERY (Section 8.8.3) to get this stored value.

8.8.2 Index Reply (DT_INDEX_REPLY)

DT_INDEX simply marks a position in the text. DT_INDEX_REPLY marks a position, but also has DECTalk inform the host computer when the index is spoken.

The DT_INDEX_REPLY escape sequence is as follows.

```
ESC P 0 ; 2 1 ; P3 z ESC \
027 080 048 059 050 049 059 *** 122 027 092
```

The P3 parameter is in the range 0 to 32767, using ASCII characters for the selected number.

When DECTalk speaks the DT_INDEX_REPLY sequence, it sends a reply (containing the P3 parameter of the index) to the host computer. The escape sequence reply format is as follows.

```
ESC P 0 ; 3 1 ; P3 z ESC \
027 080 048 059 051 049 059 *** 122 027 092
```

P3 has the original value specified in DT_INDEX_REPLY.

8.8.3 Index Query (DT_INDEX_QUERY)

DT_INDEX_QUERY requests DECTalk to reply to the host computer with the last index marker spoken (that is, the last portion of spoken text that had an index marker). The DT_INDEX_QUERY escape sequence is as follows.

```
ESC P 0 ; 2 2 z ESC \
027 080 048 059 050 050 122 027 092
```

DECTalk immediately returns a DECTalk reply escape sequence to the host computer in the following format.

```
ESC P 0 ; 3 2 ; P3 z ESC \
027 080 048 059 051 050 059 *** 122 027 092
```

P3 contains the last index spoken. The P3 value is 0 under any of the following conditions.

- The last index passed was 0.
- No index has been passed since power-up, RIS, or DECSTR.

Figure 8-1 shows how DT_SYNC and DT_INDEX_QUERY can coordinate host-DECtalk communications.

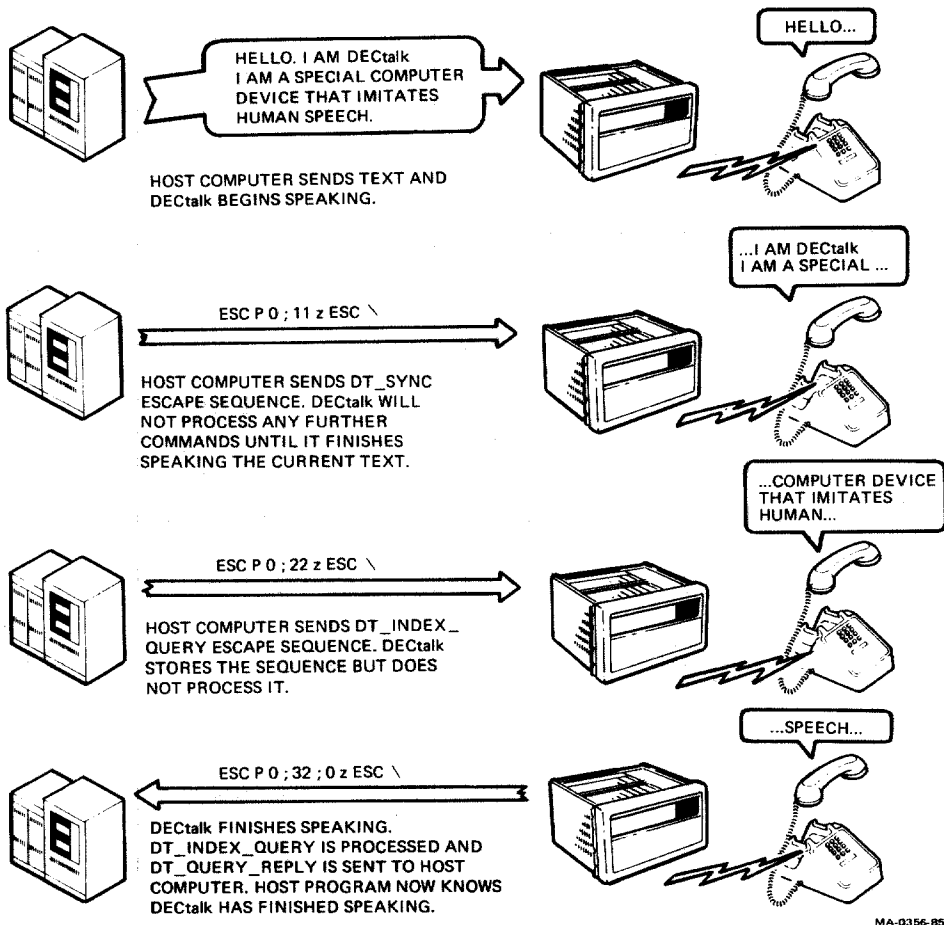

Figure 8-1 Using DT_SYNC and DT_INDEX_QUERY to Coordinate DECtalk Communications

8.9 LOAD DICTIONARY (DT_DICT)

The user dictionary is used for processing abbreviations, and for providing phonemic equivalents of unusual words. The DT_DICT escape sequence is as follows.

```
ESC P 0 ; 4 0 z name SP phonemes ESC \
027 080 048 059 052 048 122 ***** 032 ***** 027 092
```

Whenever the word represented by "name" appears in the input text, the phonemic pronunciation given by "phonemes" is used.

Any uppercase characters in the name only match uppercase characters in the input text. Lowercase characters in the name match both uppercase and lowercase characters in the input text. DECtalk always searches dictionary entries in the order entered.

If a name ends with a period (.), a period must follow the word in running input text. This period is included as part of the word, and is not recognized as a sentence terminator.

Here are some examples of dictionary entries.

```
ESC P 0 ; 4 0 ; z ms m'ihz ESC \
ESC P 0 ; 4 0 ; z ms. m'ihz ESC \
ESC P 0 ; 4 0 ; z DEC d'ehk ESC \
ESC P 0 ; 4 0 ; z dec dihs'ehmbr ESC \
ESC P 0 ; 4 0 ; z Goethe g'owth`iy ESC \
ESC P 0 ; 4 0 ; z GOSLOW :ra 120 ESC \
```

Note the use of capitalization in the previous examples to distinguish between abbreviations with the same spelling.

If you do not enter a phoneme substitution, DECtalk removes the word from the user dictionary. You cannot remove words from the built-in dictionary.

After loading the word and its definition, DECtalk replies with a dictionary status report as follows.

```
ESC P 0 ; 5 0 ; P3 z ESC \
027 080 048 059 053 048 059 *** 122 027 092
```

P3 may have one of the following values.

- 0 The word was entered correctly.
048
- 1 No room is in the dictionary.
049
- 2 The entry is too long (256 characters maximum).
050

8.10 INPUT LOGGING (DT_LOG)

The DT_LOG command controls DECtalk logging of input text. This command allows DECtalk to send the phonemes corresponding to the input text back to the host computer.

```
ESC P 0 ; 8 1 ; P3 ; P4 z ESC \
027 080 048 059 056 049 059 *** 059 *** 122 027 092
```

The P3 parameter is interpreted as a set of flag bits, with only one bit (LOG_HOSTPH, the bit with value 256) used. All other bits are ignored. The log mask is set to 0 at power-up.

If the LOG_HOSTPH bit is set (P3 = 256), DECtalk will send the phonemic representation of each clause (in ASCII characters) back to the host computer as it is generated. The standard DECtalk phonemic alphabet is used. The last logged phoneme will always be the clause delimiter. The clause delimiter will always be followed by a carriage return.

The host computer must be prepared to receive the characters when they are sent, or they will be lost. There is no flow control at all.

The P4 parameter is a level 2 device function. It controls the interpretation of the P3 parameter as follows.

- If P4 is 0, then P3 is a new log mask.
- If P4 is 1, then P3 is a set of bits to be set in the log mask.
- If P4 is 2, then P3 is a set of bits to be cleared in the log mask.

9 MODIFYING THE VOICES

This chapter shows how to change and create voices spoken by DECtalk. Changing and creating voices requires a certain knowledge of acoustic phonetics and the human voice. This chapter necessarily goes into detail on speaker-definition parameters. Understanding the information is necessary for effective voice modification and will make the task easier.

9.1 VOICE CHARACTERISTICS

The DECtalk DTC03 system has a set of simple commands that you can use to change the speaking rate, or to change the voice to one of nine different voices – male, female, child, or a user-definable voice – as shown in Figure 9-1. You can use other, more complex commands to modify the characteristics of each voice, or to create a new voice or special effects. The complex commands require skill and experience to use effectively, but the simple commands are easy to use in normal DECtalk applications.

When using the telephone, we can usually tell whether the voice of a stranger is that of a man, woman, or child. Slight differences in voice quality are characteristic of these different speakers. For example, women's and children's voices are usually higher pitched than men's voices. The size of the head and vocal tract account for some of the differences. We also notice that some people speak more quickly or more clearly than others.

Chapter 7 described ways you can modify DECtalk pronunciation. This chapter shows how you can change the DECtalk voice itself by selecting the speaking rate, sex, and other voice characteristics.



Figure 9-1 The DECtalk Voices

DECtalk has five commands that you can use to modify voice characteristics (Table 9-1). Because the commands are entered within phonemic brackets [and], you must have `MODE_SQUARE` set. This option is set on at power-up. `MODE_SQUARE` can also be set with the `DT_MODE` control sequence (Section 4.6.2.)

NOTE: `MODE_SQUARE` is provided as a default. DECtalk interprets text between square brackets as phonemes. For DECtalk to interpret the [and] and the characters between them as normal text, and not the phoneme delimiters, `MODE_SQUARE` must be cleared.

WARNING: If you forget the final], DECtalk will try to interpret ASCII text as phonemes, skipping over illegal letter combinations. If DECtalk seems to be speaking text this way, type] to recover.

The commands that modify the voice characteristics are

1. Speaking rate [:ra _]
2. Comma pause duration [:cp _]
3. Period pause duration [:pp _]
4. New voice [:n_]
5. Design voice [:dv _]

where the “_” represents a variable letter, value, or parameter.

Each of the first three commands has a single, simple function. The fourth (new voice) command selects the standard DECtalk voices. The fifth (design voice) command allows you to create a completely new voice.

Table 9-1 Voice Modification Commands

Command	Minimum	Maximum	Unit per Parameter
:ra	120	350	Words per minute
:cp	-40	30000	Milliseconds
:pp	-380	30000	Milliseconds
:n_	-	-	pbhfkruv
:dv	-	-	See Table 9-4.

9.2 SPEAKING RATE [:ra _]

The default speaking rate is 180 words per minute (wpm). Speaking rate values have been calibrated with a 300-word standard paragraph.* Speaking rates can be adjusted to be very slow, very fast, or anywhere in between by using the following commands.

[:ra 120] This rate is the slowest, 120 wpm. It is ideal for situations where material such as a phone number is to be copied down by the listener.

WARNING: *It is frustrating to listen to extended speech at slow rates unless the listener is actually copying down every word.*

[:ra 160] This rate is moderate, 160 wpm. This rate sounds a little slow, but may be preferred for telephone communication because the reduced bandwidth of the telephone channel makes human speech slightly less easy to understand than in direct-contact communication.

[:ra 180] This rate is normal (moderately fast), 180 wpm. It is the default rate for DECtalk, and is ideal for listening to continuous text under optimal conditions.

[:ra 240] This rate is fast, 240 wpm. Practiced listeners can skim material at this rate and prefer it when scanning text for important sections. Inexperienced listeners may not understand every word at this rate.

[:ra 350] This rate is the fastest, 350 wpm. It is too fast for most people to follow, but it may have applications in special circumstances.

Any speaking rates between 120 and 350 are permitted in the [:ra _] command. Rates specified outside this range are limited to the nearest legal value.

* Fairbanks, G. *Voice and Articulation Drill Book*. Second Edition. Harper and Row, 1960, p. 114.

Changes in speaking rate influence the duration and especially the number of pauses in text, as well as the duration of individual phonemes. At rates below 140 wpm, DECTalk inserts pauses at all phrase boundaries. At rates faster than 240 wpm, DECTalk deletes the comma pause. At slow rates, pauses and phonemes near the ends of phrases are lengthened considerably. At fast rates, these pauses and phonemes are shortened. (Near the beginning of phrases, phonemes are fairly short at both slow and fast speaking rates.)

9.3 PAUSE DURATIONS [:pp _] and [:cp _]

At the normal speaking rate of 180 words per minute, DECTalk pauses about half a second after a period in the text and about a sixth of a second after a comma. These pause durations are adjusted appropriately when you change the speaking rate.

In some situations, you might like a pause after a period without changing the speaking rate. For example, to get DECTalk to read a list of words at a normal rate with 5-second pauses after each word (to allow the listener to write them down), you could use one of the following commands and end each word with a comma (continuation rise intonation) or a period (falling intonation).

- [:pp 4500] Add a period pause of 4500 ms to the standard half-second pause that occurs after a period in the text. The total pause between words will be 5 seconds.
- [:cp 4830] Add a comma pause of 4830 ms to the standard sixth of a second pause that occurs after a comma in the text at normal speaking rate. The total pause between words separated by a comma will be 5 seconds.
- [:pp 0 :cp 0] Reset the period pause and comma pause to their normal default values.

The permitted range for a period pause is from -380 to 30000 ms. A negative value shortens the standard period pause. The permitted range for a comma pause is from -40 to 30000 ms. Values specified outside this range will be limited to the nearest legal value.

9.4 SELECTING A STANDARD VOICE [:n_]

DECtalk has nine built-in voices and one voice that is user definable. You can refer to each voice by the command [:n_] where “_” is a letter representing one of the DECtalk voices. Table 9-2 lists the [:n_] symbols.

You can change voices with the new voice command as in this example.

```
[:nb] Hello. I'm Betty.
```

You can also change voices in the middle of a sentence.

```
[:np] This is a demo [:nb] of a sudden change in voice.
```

Table 9-2 New Voice Commands

:n_ Parameter	Voice Name	Characteristics
:np	Perfect Paul	Standard male voice
:nb	Beautiful Betty	Standard female voice
:nh	Huge Harry	Deep male voice
:nf	Frail Frank	Older male voice
:nk	Kit the Kid	Child's voice (male or female, about 10 years old)
:nr	Rough Rita	Deep female voice
:nu	Uppity Ursula	Light female voice
:nd	Doctor Dennis	Breathy male voice
:nw	Whispering Wendy	Whispery female voice
:nv	Variable Val	User-definable voice

DECtalk needs a brief silence to change to a new built-in voice. If a voice change request occurs in the middle of a sentence, DECtalk automatically pauses slightly. The pause is the equivalent of inserting a comma before the midsentence command. For example, you could type the previous sentence as follows.

[:np] This is a demo, [:nb] of a sudden change in voice.

It is good practice to always end a sentence (insert a period) before changing voices. This allows the listener to prepare for a new speaker.

9.5 DESIGNING A VOICE WITH SPEAKER-DEFINITION PARAMETERS [:dv _]

The DECtalk voices provide an adequate selection for most user's applications. However, if you have a special application requiring a monotone or unusual voice (for example, the voice of a vocally handicapped person), you can modify the parameters defined in this section on a trial-and-error basis to get the desired voice.

The nine built-in voices of DECtalk are distinguished from one another by a large set of speaker-definition parameters. Table 9-3 lists these parameters and their ranges. Table 9-4 lists the parameters for all DECtalk voices.

Speakers can differ in sex, age, head size and shape, larynx size and behavior, pitch range, pitch and timing habits, dialect, and emotional state. DECtalk cannot approximate all of these options. Therefore, the space of distinguishable voices is quite limited, even though DECtalk has many speaker-definition parameters that can be modified.

The design voice [:dv _] command introduces the speaker-definition parameters that can be entered as a string or one at a time.

The following sections discuss speech production, acoustics, and perception. Some of the information may be difficult to follow, but the examples should make it possible for all users to effectively modify any parameter and listen to the results.

Table 9-3 Speaker Definition [:dv _] Parameter Range

Parameter	Minimum	Maximum	Unit	Function
save	-	-	-	Save current speaker definition in variable buffer.
Vocal Tract Parameters				
sx	0	1	-	Set sex to female (0 or f) or male (1 or m).
hs	65	145	%	Head size
f4	2000	4650	Hz	Fourth formant frequency
f5	2500	4950	Hz	Fifth formant frequency
b4	100	2048	Hz	Fourth formant bandwidth
b5	100	2048	Hz	Fifth formant bandwidth
Voicing Sound Source Parameters				
br	0	72	dB	Breathiness
lx	0	100	%	Lax breathiness
sm	0	100	%	Smoothness (high frequency attenuation)
ri	0	100	%	Richness
nf	0	100	-	Number of fixed samplings of glottal pulse open phase
la	0	100	%	Laryngealization

Table 9-3 Speaker Definition [:dv _] Parameter Range (Cont.)

Parameter	Minimum	Maximum	Unit	Function
Intonation Parameters				
bf	0	40	Hz	Baseline fall
hr	2	100	Hz	Hat rise
sr	1	100	Hz	Stress rise
as	0	100	%	Assertiveness
qu	0	100	%	Quickness
ap	50	350	Hz	Average pitch
pr	0	250	%	Pitch range
Gain Adjustment Parameters				
lo	0	86	dB	Loudness of the voice
gv	0	86	dB	Gain of voicing source
gh	0	86	dB	Gain of aspiration source
gf	0	86	dB	Gain of frication source
g1	0	86	dB	Gain of cascade formant resonator 1
g2	0	86	dB	Gain of cascade formant resonator 2
g3	0	86	dB	Gain of cascade formant resonator 3
g4	0	86	dB	Gain of cascade formant resonator 4

Table 9-4 Speaker Definitions for All DECtalk Voices

Parameter	Paul	Harry	Frank	Dennis	Betty	Ursula	Wendy	Rita	Kit
sx	1	1	1	1	0	0	0	0	0
hs	100	115	90	105	100	95	100	95	80
f4	3300	3300	3650	3200	4450	4500	4500	4000	2500
f5	3650	3850	4200	3600	2500	2500	2500	2500	2500
b4	260	200	280	240	260	230	400	250	2048
b5	330	240	300	280	2048	2048	2048	2048	2048
br	0	0	50	38	0	0	55	46	47
lx	0	0	50	70	80	50	80	0	75
sm	3	12	46	100	4	60	100	24	5
ri	70	86	40	0	40	100	0	20	40
nf	0	10	0	10	0	10	10	0	0
la	0	0	5	0	0	0	0	4	0
bf	18	9	9	9	0	8	0	0	0
hr	18	20	20	20	14	20	20	20	20
sr	32	30	22	22	20	32	22	32	22
as	100	100	65	100	35	100	50	65	65
qu	40	10	0	50	55	30	10	30	50
ap	122	89	155	110	208	240	200	106	306
pr	100	80	90	135	140	135	175	80	210
lo	86	81	86	84	81	80	83	83	73
gv	65	65	65	65	65	65	53	65	65
gh	70	70	70	70	70	70	70	70	70
gf	70	70	70	70	72	72	72	72	72
g1	68	73	63	75	69	69	69	69	69
g2	60	60	58	60	67	66	62	72	69
g3	49	52	56	52	50	51	53	48	53
g4	65	63	67	62	57	59	55	54	50

9.5.1 Changing Sex and Head Size

Six speaker-definition parameters control the size and shape of the head. These parameters are listed below and are described in Sections 9.5.1.1 through 9.5.1.3.

sx	Sex, m or f, 1 or 0
hs	Head size, in percent
f4	Fourth formant resonance frequency, in Hz
f5	Fifth formant resonance frequency, in Hz
b4	Fourth formant bandwidth, in Hz
b5	Fifth formant bandwidth, in Hz

9.5.1.1 Sex, sx – Male and female voices have many differences, including head size, pharynx length, larynx mass, and speaking habits such as degree of breathiness, liveliness of pitch, choice of articulatory target values, and speed of articulation. Some of these differences are under the control of a single parameter, *sx*, the sex of the speaker. Speakers Paul, Harry, Frank, and Dennis are male (*sx* = 1), while speakers Betty, Rita, Ursula, Wendy, and Kit are female (*sx* = 0). Actually, Kit the Kid can be male or female because children younger than 10 years old have similar voices for both sexes.

Changing the *sx* parameter causes DECTalk to access a different (male or female) table of target values for formant frequencies, bandwidths, and source amplitudes. The male and female tables are patterned after two individuals who were judged to have pleasant, intelligible voices. DECTalk's built-in voices are only scaled transformations of Paul and Betty, the two basic voices.

You can change the sex of any of DECTalk's voices by making the voice current and then modifying the *sx* parameter. For example, the following command gives Paul some of the speaking characteristics of a woman. (The *sx* parameter does not change the average pitch or breathiness, so a peculiar combination of simultaneous male and female traits results from this *sx* change.)

```
[ :np :dv sx 0] Am I a man or woman?
```

The `sx` parameter can also be specified as `m` or `f` with the commands `[:dv sx m]` or `[:dv sx f]`.

WARNING: *If you change the sex of the voice, some phonemes may cause DECTalk's filters to overload, producing a squawk. (The squawk is unpleasant, but it will not damage DECTalk.) Sections 9.5.1.3 and 9.5.4.3 describe parameters `f4`, `f5`, and `g1` and explain how to correct this problem.*

9.5.1.2 Head Size, `hs` – Head size is specified as the average size for an adult man (if `sx = 1`) or an adult woman (if `sx = 0`). A head size of 100 percent is normal or average for a given sex, but people can differ quite a bit in this characteristic. Head size has a strong influence on a person's voice. Large musical instruments produce low notes, and humans with large heads tend to have low, resonant voices. For example, to make Paul sound like a larger man with a 15 percent longer vocal tract (and formant frequencies that are scaled down by a factor of about 0.85 percent), type the following command.

```
[:np :dv hs 115] Do I sound more like Huge Harry this way?
```

Head size is one of the best variables to use if you want to make dramatic voice changes. For example, Paul has a head size of 100, while Harry's deep voice is caused in part by a head size change to 115, or 15 percent greater than normal. Decreasing head size produces a higher voice, such as in a child or adolescent. Extreme changes in head size, as in the following examples, are somewhat difficult to understand.

```
[:nh :dv hs 135] Do I have a swelled head?
```

```
[:nk] I am about 10 years old.
```

```
[:nk :dv hs 65] Do I sound like a six year old?
```

WARNING: *Extreme changes in head size can cause overloads, as well as difficulties in understanding the speech. To correct an overload, see Sections 9.5.1.3 and 9.5.4.3 on parameters `f4`, `f5`, and `g1`.*

9.5.1.3 Higher Formants, f4, f5, b4, and b5 – A male voice typically has five prominent resonant peaks in the spectrum (over the range from 0 to 5 kHz), a female voice typically has only four (due to a smaller head size), and a child has three. If fourth and fifth formant resonances exist for a particular voice, they are fixed in frequency and bandwidth characteristics. These characteristics are specified by the parameters f4, f5, b4, and b5, in Hz. Values for each predefined voice are in Table 9-4.

If a higher formant does not exist, the frequency and bandwidth of the speaker definition are set to special values that cause the resonance to disappear. To make a resonance disappear, the frequency is set to 2500 Hz, and the bandwidth to 2048 Hz. This is what has been done to the fourth and fifth formants for Kit the Kid (Table 9-4).

The permitted values for f4 and f5 have fairly complicated restrictions. Violating these restrictions can cause overloads and squawks. The restrictions are listed below for cases where a higher formant exists.

1. F5 must be at least 300 Hz higher than f4.
2. If sx is male, f4 must be at least 3250 Hz. •
3. If sx is female, f4 must be at least 3700 Hz.
4. If hs is not 100, the above values should be multiplied by $(hs / 100)$.

These higher formants produce peaks in the spectrum that become more prominent if b4 and b5 are smaller, and if f4 and f5 are closer together. The limits placed on b4 and b5 (Table 9-3) should ensure that no problems occur. However, smaller values for bandwidths may produce an overload in the synthesizer. You can correct these overloads by increasing the bandwidths or by changing the gain control g1 (Section 9.5.4.3).

9.5.2 Changing Voice Quality

Six speaker-definition parameters control aspects of the output of the larynx, which, in turn, control voice quality. These parameters are listed below and are described in Sections 9.5.2.1 through 9.5.2.6.

br	Breathiness, in decibels (dB)
lx	Lax breathiness, in percent
sm	Smoothness, in percent
ri	Richness, in percent
nf	Number of fixed samples of open glottis
la	Laryngealization, in percent

9.5.2.1 Breathiness, br – Some voices can be characterized as breathy. The vocal folds vibrate to generate voicing and breath noise simultaneously. Breathiness is a characteristic of many female voices, but it is also common under certain circumstances for male voices.

The range of the br parameter is from 0 dB (no breathiness) to 70 dB (strong breathiness). By experimenting, you can learn what intermediate values sound like. Noting breathiness values in Table 9-4 for each of the predefined speakers may also help. For example, to turn Paul into a breathy, whispering speaker, type the following command.

```
[ :np :dv br 55 gv 56] Do I sound more like Doctor Dennis now?
```

This voice is not as loud as the others due to the simultaneous decrease in the gain of voicing, gv, but it is intelligible and human sounding.

9.5.2.2 Lax Breathiness, lx – The br parameter (Section 9.5.2.1) creates simultaneous breathiness whenever voicing is turned on. Another type of breathiness occurs only at the ends of sentences and when going from voiced to voiceless sounds. This type of “lax” breathiness is controlled by the lx parameter in percent.

A nonbreathy, tense voice would have lx set to 0, while a maximally breathy, lax voice would have lx set to 100. The difference between these two voices is not great, but you can hear it if you listen closely.

9.5.2.3 Smoothness, sm – Smoothness refers to vocal fold vibrations. The vocal folds meet at the midline, as they do in normal voicing, but they do not slam together forcefully to create a very sudden cessation of airflow.

DECtalk uses a variable-cutoff, gradual low-pass filter to model changes to smoothness. The range of sm is from 0 percent (least smooth and most brilliant) to 100 percent (most smooth and least brilliant). The voicing source spectrum is tilted so that energy at higher frequencies is attenuated by as much as 30 dB when smoothness is set to a maximum, but is not attenuated at all when smoothness is set to 0.

Professional singing voices that are trained to sing above an orchestra are usually brilliant, while anyone who talks softly becomes breathy and smooth. To synthesize a breathy voice, an sm value of about 50 or more is good. Changes to sm do not have a great effect on perceived voice quality.

9.5.2.4 Richness, ri – Richness is similar to smoothness and brilliance, except that the spectral change occurs at lower frequencies, and is due to a different physiological mechanism. Brilliant, rich voices carry well and are more intelligible in noisy environments, while smooth soft voices sound more friendly. For example, typing the following command produces a soft, smooth version of Paul's voice.

```
[ :np :dv ri 0 sm 70] Do I sound more mellow?
```

The following command produces a maximally rich and brilliant (forceful) voice.

```
[ :np :dv ri 90 sm 0] Do I sound more forceful?
```

Smoothness and richness are usually negatively correlated when a speaker dynamically changes laryngeal output. The sm and ri parameters do not influence the speaker's identity very much.

9.5.2.5 Nopen Fixed, nf – The number of samples in the open part of the glottal cycle is determined not only by *ri*, but also by a second parameter, *nf*. *NF* is the number of fixed samples in the open portion of the glottal cycle.

Most speakers adjust the open phase to be a certain fraction of the period, and this fraction is determined by *ri*. Other speakers keep the open phase fixed in duration when the overall period varies. To simulate this behavior, set *ri* to 100 and adjust *nf* to the desired duration of the open phase. The shortest possible open phase is 10 (1 ms), and the longest is three quarters of the period duration (about 70 for a male voice).

9.5.2.6 Laryngealization, la – Many speakers turn voicing on and off irregularly at the beginnings and ends of sentences, which gives a querulous tone to the voice. This departure from perfect periodicity is called laryngealization or creaky voice quality.

The *la* parameter controls the amount of laryngealization in the voice. A value of 0 results in no laryngealized irregularity, and a value of 100 (the maximum) produces laryngealization at all times.

For example, to make Betty moderately laryngealized, type the following command.

```
[ :nb :dv la 20]
```

The *la* parameter creates a noticeable difference in the voice, although it is not altogether a pleasant change.

9.5.3 Changing the Pitch and Intonation of the Voice

Seven speaker-definition parameters control aspects of the fundamental frequency (f_0) contour of the voice. These parameters are listed below and are described in Sections 9.5.3.1 through 9.5.3.6.

bf	Baseline fall, in Hz
hr	Hat rise, in Hz
sr	Stress rise, in Hz
as	Assertiveness, in percent
qu	Quickness, in percent
ap	Average pitch, in Hz
pr	Pitch range, in percent

9.5.3.1 Baseline Fall, bf – The bf parameter (baseline fall in Hz) determines one aspect of the dynamic fundamental frequency contour for a sentence. If bf is 0, the reference baseline fundamental frequency of a sentence begins at 115 Hz and ends at this frequency. All rule-governed dynamic swings in f_0 are computed with respect to the reference baseline.

Some speakers begin a sentence at a higher f_0 , and gradually fall as the sentence progresses. This “falling baseline” behavior can be simulated by setting bf to the desired fall in Hz. For example, setting bf to 20 Hz will cause the f_0 pattern for a sentence to begin at 125 Hz (115 Hz plus half of bf), and fall at a rate of 16 Hz per second until it reaches 105 Hz (115 Hz minus half of bf). The baseline remains at this lower value until it is reset automatically before the beginning of the next full sentence (right after a period, question mark, or exclamation point). The rate of fall, 16 Hz per second, is fixed, no matter what the extent of the fall.

Whenever you include a [+] phoneme in the text to indicate the beginning of a paragraph, the baseline is automatically set to begin slightly higher for the first sentence of the paragraph. The following sentences of a paragraph are all identical in having a normal baseline fall.

While baseline fall differs among the speakers, it is not a very good cue for differentiating between speakers. As long as the fall is not excessive, its presence or absence is not particularly noticeable.

9.5.3.2 Hat Rise, hr – The hr (nominal hat rise in Hz) and sr (nominal stress impulse rise in Hz) parameters determine aspects of the dynamic fundamental frequency contour for a sentence. To modify these values selectively, you should understand how the f0 contour is computed as a function of lexical stress pattern and syntactic structure of the sentence.

A sentence is first analyzed and broken into clauses with punctuation and clause-introducing words to determine the locations of clause boundaries. Within each clause, the f0 contour rises on the first stressed syllable, stays at a high level for the remainder of the clause up to the last stressed syllable, and falls dramatically on the last stressed syllable. The rise-at-the-beginning and fall-at-the-end pattern has been called the “hat pattern” by linguists, using the analogy of jumping from the brim of a hat to the top of the hat, and back down again.

The hat rise parameter, hr, indicates the nominal height in hertz of a pitch rise to a plateau on the first stress of a phrase. A corresponding pitch fall is placed by rule on the last stress of the phrase. Some speakers use relatively large hat rises and falls, while others use a local “impulse-like” rise and fall on each stressed syllable. (See Section 9.5.3.3.) The default hr value for Paul is 22 Hz, indicating that the f0 contour rises a nominal 22 Hz when going from the brim to the top of the hat. To simulate a speaker who does not use hat rises and falls, enter the command [:dv hr 0].

Other aspects of the hat pattern are important for natural intonation but are not accessible by speaker-definition commands. For example, the hat fall becomes a weaker fall followed by a slight continuation rise if the clause is to be succeeded by more clauses in the same sentence. Also, if unstressed syllables follow the last stressed syllable in a clause, part of the hat fall occurs on the very last (unstressed) syllable of the clause. If the clause is long, DECtalk may break it into two hat patterns by finding the boundary between the noun phrase and verb phrase.

If DECtalk is in phoneme input mode and you use the pitch rise [/] and pitch fall [\] symbols (Section 7.6.5), the hr parameter determines the actual rise and fall in Hz.

9.5.3.3 Stress Rise, sr – The sr parameter indicates the nominal height, in Hz, of a local pitch rise and fall on each stressed syllable. This rise-fall is added to any hat rise or fall that may also be present. (See Section 9.5.3.2.) For example, Paul has pr set to 32 Hz, resulting in an f0 rise-fall gesture of 32 Hz over a span of about 150 ms, which is located on the first and succeeding stressed syllables. However, DECTalk rules reduce the actual height of successive stress rises and falls in each clause, and cause the last stress pulse to occur early so that there is time for the hat fall during the vowel.

If the sr parameter is set too low, the speech sounds monotone within long phrases. Great changes to hr and sr from their default values for each speaker are not necessary or desirable, except in unusual circumstances.

9.5.3.4 Assertiveness, as – Assertive voices have a dramatic fall in pitch at the end of utterances. Neutral or meek speakers often end a sentence with a slight “questioning” rise in pitch to deflect any challenges to their assertions. The as parameter, in percent, indicates the degree to which the voice tends to end statements with a conclusive final fall. A value of 100 is very assertive, while a value of 0 is maximally meek.

9.5.3.5 Quickness, qu – The qu parameter, in percent, controls the speed of response to a request to change the pitch. All hat rises, hat falls, and stress rises can be thought of as suddenly applied commands to change the pitch, but the larynx is sluggish, and responds only gradually to each command. A smaller larynx typically responds more quickly, so while Harry has a quickness value of 10, Kit has a value of 50.

In engineering terms, a value of 10 implies a time constant (time to get to 70 percent of a suddenly applied step target) of about 100 ms. A value of 90 percent corresponds to a time constant of about 50 ms. Lower quickness values may mean that the f0 never quite reaches the target value before a new command comes along to change the target, but this is perfectly natural.

9.5.3.6 Average Pitch, ap, and Pitch Range, pr – The ap (average pitch in Hz) and pr (pitch range in percent of normal range) parameters modify the computed values of fundamental frequency, f0, according to the formula:

$$f_0' = ap + (((f_0 - 120) * pr) / 100)$$

If `ap` is set to 120 Hz and `pr` to 100 percent, there will be no change to the "normal" `f0` contour that is computed for a typical male voice. The effect of a change in `ap` is simply to independently raise or lower the entire pitch contour by a constant number of Hz, while the effect of `pr` is to expand or contract the swings in pitch about 120 Hz.

Normally, a smaller larynx simultaneously produces `f0` values that are higher in average pitch and higher in pitch range by about the same factor (the whole `f0` contour is multiplied by a constant factor). Observing the values assigned to `ap` and `pr` for each of the voices (Table 9-4), you can see that the voices rank in average pitch from low (Harry) to high (Kit). Rankings for `pr` are similar, except that Frank has a flat, nonexpressive pitch range compared with his average pitch.

The best way to determine a good pitch range for a new voice is by trial and error. You can create a monotone or robot-like voice by setting the pitch range to 0. For example, to make Harry speak in a monotone at exactly 90 Hz, type the following command.

```
[:nh :dv ap 90 pr 0] I am a robot.
```

Reducing the pitch range reduces the dynamics of the voice, producing emotions such as sadness. Increasing the pitch range while leaving the average pitch the same or setting it slightly higher suggests excitement.

Due to constraints involved in pitch-synchronous updating of other dynamically changing parameters, the fundamental frequency contour that is computed by the above formula is then checked for values that are out of bounds with respect to the following limits.

`f0` maximum = 500 Hz

`f0` minimum = 50 Hz

Any value outside this range is limited to fall within the range.

To keep you from exceeding reasonable limits on the parameters controlling pitch, the constraints in Table 9-3 have been placed on values selected. If a `[:dv _]` command requests values outside these limits, the request is limited to the nearest listed value before execution.

9.5.4 Changing Relative Gains and Avoiding Overloads

Eight speaker-definition parameters control the output levels of various internal resonators. These parameters are listed below and are described in Sections 9.5.4.1 through 9.5.4.3.

lo	Loudness of the voice, in dB
gv	Gain of voicing source, in dB
gh	Gain of aspiration source, in dB
gf	Gain of frication source, in dB
g1	Gain of cascade formant resonator 1, in dB
g2	Gain of cascade formant resonator 2, in dB
g3	Gain of cascade formant resonator 3, in dB
g4	Gain of cascade formant resonator 4, in dB

9.5.4.1 Loudness, lo – Each predefined voice has been adjusted to have about the same perceived loudness, a value that is about optimum for telephone conversation. The value chosen is near maximum (if loudness were increased much, some phonemes would probably cause an overload squawk). A near maximum value was selected to maximize the signal-to-noise level of DECTalk.

If you want to decrease the loudness of a voice, or make a temporary increase for a phrase that is known not to overload, determine the lo value in dB for the voice in question by referring to Table 9-4. Then adjust the voice by using the following command.

```
[ :np :dv lo 76]. I am speaking at about half my normal level.
```

Because the lo entry in Table 9-4 for Paul is 86, this command reduces loudness by 10 dB. Perceived loudness approximately doubles (or halves) for each 10 dB increment (decrement) in lo.

Software control over loudness is useful in a loudspeaker application where the background noise level in the room might change. For example, a vocally handicapped wheelchair-bound person does not want to appear to be shouting in a quiet interpersonal conversation, but may wish to be able to converse in a noisy room as well. Using a software abbreviation facility, such a person could type lo to select a command making the voice maximally loud, and sof to invoke a command setting lo to a reduced value.

9.5.4.2 Sound Source Gains, g_v , g_h , and g_f – Three types of sound sources are activated during speech production: voicing, aspiration, and frication. The relative output levels of these three sounds, in dB, are determined by the g_v , g_h , and g_f parameters respectively. The default settings (Table 9-4) for these parameters have been factory preset to maximize the intelligibility of each voice. However, changing the settings can be useful in debugging the system or in demonstrating aspects of the acoustic theory of speech production. You could change the level of one sound source globally, for example, turning off frication can allow you to hear just the output of the larynx. These parameters might have to be reduced to overcome certain kinds of overloads, but try the procedure in the next section first.

9.5.4.3 Cascade Vocal Tract Gains, g_1 , g_2 , g_3 , and g_4 – Changes in head size or other parameters can sometimes produce overloads in the synthesizer circuits. If this occurs, first check to see that f_4 and f_5 are set to reasonable values. If the squawk remains, you can adjust several gain controls, g_1 through g_4 in dB, in the cascade of formant resonators of the synthesizer to attenuate the signal at critical points. These gains can then be amplified back to desired output levels later in the synthesis.

Use the following procedure to correct an overload (typically indicated by a squawk during part of a word).

1. Synthesize the word or phrase several times to make sure the squawk occurs consistently. Use the same test word each time one of the following changes to a gain is made.
2. See Table 9-4 to determine the default values for g_1 through g_4 for the speaker that overloads.
3. Reduce g_1 by an increment of 3 at a time until the squawk goes away. When the squawk goes away, note the reduction that was needed. If more than a 10 dB decrement is required, some other parameter has probably been changed too much. If the squawk does not go away at all, then you may need to reduce g_v instead of g_1 .
4. Add this increment to l_0 to return the output to its original level. For example, if g_1 was reduced by 6 dB, add 6 dB to l_0 (or g_4 if l_0 is already at a maximum). If incrementing l_0 causes the squawk to return, then decrease l_0 slowly until the squawk goes away.

This procedure works in most cases, but using g2 rather than g1 can work better. If you can return g1 to its factory preset value (Table 9-4) and reduce g2 instead to make the squawk go away, then the signal-to-quantization-noise level in g1 remains maximized. If you can fix the squawk by using g3 or g4 rather than g2, more of the cascaded resonator system can be made immune to quantization noise accumulation.

9.5.5 The [save] Parameter and [:nv] Voice

You can save a modified speaker definition in a buffer while synthesizing speech with one of the other voices. The Variable Val voice [:nv] is either male or female, depending on what values are stored in the buffer. If you call Val before storing any values in the buffer, DECTalk uses the Perfect Paul voice [:np]. The following commands store a modified Betty voice in Val and then recall it.

```
[:nb :dv sex m save]
(Store the modified Betty voice in Val.)
```

```
[:np] I am Paul.
(Use another voice.)
```

```
[:nv] I am Val.
(Recall the Val [modified-Betty] voice.)
```

The buffer holds its contents until you power down DECTalk. You must reenter new voice characteristics if you turn off DECTalk.

9.5.6 Summary on Speaker-Definition Parameters

Of the 27 parameters, only a few cause dramatic changes in the voice. The greatest effects are obtained with changes to hs, ap, pr, and sx, while moderate changes occur when modifying la and br. To some extent, DECTalk's nine factory-set speakers cover most of the possible voices, so don't expect to be able to find a voice that is highly novel and intelligible. However, you might easily find ways to slightly improve one of the standard voices.

9.6 VOICE COMMAND SYNTAX

DECTalk uses the following voice command syntax rules.

1. Begin every command with a colon (:).
2. Separate each command and its parameter(s) from the text by a valid word boundary marker such as a space, tab, or carriage return.

3. You can include several commands in the same square bracket set.

`[:ra 150 :nb]` Hello. How are you?

4. You can include several parameters in the same square bracket set if the command allows more than one parameter. If you use several parameters, you must give them all before a second command in the same square bracket set.

`[:dv ap 160 pr 50 save :nv]` Hi there.
(The parameter group modifies the `[:dv _]` command.)

`[:dv ap 160 save :nv pr 50]` Hi there.
(Wrong. The parameter group is out of place.)

5. If you give two conflicting parameters or commands, DECtalk will use the last command in the sequence. For example, if you type

`[:nb :np]` Hello.

DECtalk will use Paul's voice.

6. You can use phonemic symbols in the same square brackets with voice commands.

Now I'm `[:dv ap 90 pr 130 r''ilyly]` thrilled!

7. If the value in a `[:dv _]` command is too low, DECtalk will use the minimum valid value. If the value is too high, the maximum valid value will be used.

8. Once you give a command, that command applies to all further text until overridden by another command. For example, the command

`[:nk]`

will make DECtalk use Kit's voice on all entered text until you enter another new voice command.

9. All `[:dv _]` commands are lost when you power down DECtalk.
10. Invalid commands are ignored.

10 HOW TO GET THE MOST OUT OF DECtalk

This chapter gives basic rules on how to develop an application and examples of how to use DECtalk in the most efficient way.

10.1 DEVELOPING YOUR APPLICATION

DECtalk lets people use computer-based applications from any keypad telephone. DECtalk speaks messages in an understandable voice. When the user presses keypad keys, DECtalk sends characters to the host program. The following guidelines are for adapting an application to unique customer needs.

General Guidelines

- Relate to the problem from the user's point of view, not the programmer's. Use commands that are logically related to the way users see the task.
- Frequent users become experts quickly.

Writing Dialog

- Keep dialog simple, but meaningful.
- Organize each message as follows.
 1. Put the hardest elements to remember first.
 2. Put the easiest elements to remember in the middle.
 3. Put information for immediate recall at the end.
- Tell users only what they need to know to continue a task.
- Do not use humor or threats. Keep dialog strictly factual and informative. For example, say "Please try again," rather than "Let's try again."

Help Messages and Replies

- Make help messages optional. Let users decide when they want more information.
- Repeat significant phrases in help messages.
- Let users know that DECtalk is acting on their specific commands. For example, say "Sending reply to Ms. Jones," rather than "Sending reply."

Entering Keypad Commands

- Remember, a telephone keypad has only 12 keys.
- Keep the same function on the same key.
- Refer to keypad numbers, not letters. People do not remember which letter is on which key. Use "Press 1 for next, 2 for previous, 3 to exit," rather than "Press N for next, P for previous, E to exit."
- Create a standard method for users to exit from a subtask to the main dialog.

10.1.1 Names, Part Numbers, and Alphanumeric Text

In many DECtalk applications, you use the 12 keypad keys to enter a person's name or an alphanumeric part number. Because the application program receives only a string of digits (and the # and * characters), the program must use the digits as an index to the actual data item.

If you are designing a new system, you could specify numeric part numbers only. However, in the real world, a company is not going to change its existing warehouse methods to match DECtalk. The user will have to enter something that your application can translate into the current system.

10.1.2 Direct Numeric Encoding

Using this method, the user simply presses the key labeled with the desired letter. For example, to select "DIGITAL" the user would press 3444825. You could assign the letters Q and Z to the 7 (PQRS) and 9 (WXYZ) keys, respectively.

Numeric encoding is a simple method to describe and implement. Because users can recall more than one item for a given digit string, your application must provide a way to select alternatives. You could have users select alternatives by number, or you could have them step through a list by using next and previous commands.

Numeric encoding is probably the best method for lists of names and for many part number applications. You can use this method for ID or password entry.

10.1.3 Two-Character Encoding

Some applications use specific letters in their codes (for example, three-character airport codes). You cannot use direct numeric encoding to select specific letters on the keypad.

One possible solution is two-character encoding. This method matches the three letters on each key to the three columns of keys on the keypad. The user presses two keys to select a letter.

1. The key with the desired letter
2. The 1, 2, or 3 key (to select the specific letter)

For example, to select "DEC," the user would press 313223. You could have users enter numbers together with the 0 (OPER) key. And you could assign the missing Q and Z (plus the space character) to the 1 key.

10.1.4 Ending Commands and Data

You can use single-character commands and fixed-length data fields for many applications. But for complex applications or variable-length data, you may find it simpler to ask the user to end all commands and data by pressing a special key (such as #). Pressing # lets the program know that the right number of characters have been entered.

10.1.5 Application Development Tips

Here are some tips for encoding the application itself.

- Use timeouts for everything. Assume that the user may hang up the phone at any time. Also assume that data entry will be quite slow. This is important when planning data base entry and record-locking strategies.
- People can recall about 5 seconds of text without difficulty. You can use entries such as "1 for yes, 2 for no, 3 for maybe," but do not ask an untrained user to remember anything more complex.
- DECTalk tends to spell out text that may be ambiguous (for example, part numbers). You can write a small subroutine that recognizes certain strings and pronounces them in a form more suitable for your specific application.
- If your application accepts data from the telephone keypad, make sure the operating system can buffer type-ahead characters. Also, make sure the operating system responds to DECTalk's XOFFs.
- DECTalk speaks pending text if the host computer stops delivering text for 5 seconds. This feature may be a problem on an overloaded system. You may need help from the system manager to get more resources or adjust program priorities.
- When you have DECTalk speak information from a data base, remember that the listener hears the information only once. You should offer a *repeat* function for complex subject matter. If you have DECTalk read mail or other unstructured text, you should offer a *back up one sentence* function by using the index commands (Section 8.8) to signal what has been heard.

10.2 DEVELOPING AN ADVANCED APPLICATION

The development process described in this manual assumes that your application has full control over the text being spoken. If you are developing an application that must read arbitrary text (such as electronic mail messages), your task is more difficult because almost anything can appear in the text.

In most applications, DECtalk is controlled by a computer. Even the smallest personal computer has enough power to preprocess (filter) text to handle application-unique cases. So, you can put application-specific text filters in the controlling computer, rather than add many additional special cases (and switches to enable and disable them) to DECtalk.

For an electronic mail system, you can program an electronic mail preprocessor to make the following text conversions before sending the text to DECtalk.

1. Parse the header boilerplate to remove extraneous information.
2. If DECtalk is speaking paragraphs of text, add the [-] symbol to a blank line separating each paragraph.
3. If words are separated by / or another special character, replace the / with a space ("Raleigh/Durham" should become "Raleigh Durham" for DECtalk to say it without spelling out the entire string).
4. Write your own application-specific dictionary for words, such as proper names, that DECtalk mispronounces. If DECtalk is connected to a data base containing names, consider adding a pronunciation field to the name record, entering phonemic text when appropriate.

5. Scan the text for strings of numbers in a format understandable to your application but not to DECtalk. For example, if you can extract the time format from an electronic mail message, you can add code to your application to expand it to its "o'clock" form.
6. In many applications, the listener will want to write down number strings (such as prices or telephone numbers). Your application can scan the text for strings of numbers and, when found, send them to DECtalk in a way that includes pauses at critical locations. For example:

The number is, 1 (800) 5 5 5, 1 2 3 4. [:ra 120]

That is, [_<300>] 1 (800), [_<500>] 5 5 5, [_<900>] 1 2 3 4. [:ra 180].

The spaces between the numbers ensure that "five five five" is spoken rather than "five hundred and fifty five." The slower speaking rate and the silence phonemes of specified durations were carefully selected to permit enough time for the listener to write down the entire number. Silence phonemes were positioned after an orthographic comma to minimally disturb the intonation.

As another example, if your application speaks money (such as bank balances or item costs), it might say

Your balance is \$244.05

That is, 2 4 4, [_<400>] point 0 5, [_<400>] dollars.

7. When spelling an item out, your application may have to distinguish the case of letters. Consider using different voices to distinguish between uppercase and lowercase letters (for example, Harry and Paul).

10.3 OPTIMIZING THE QUALITY OF SPOKEN TEXT

In some applications, it is important to get a few sentences to sound very good because they are used often (for example, to open a dialog with a customer). Usually DECtalk does a satisfactory job, but sometimes it mispronounces a word or gets the phrasing wrong. In these cases, you may wish to spend the time required to optimize the quality of a particular sentence. The following steps are suggested.

1. Send the sentence to DECtalk and listen repeatedly, focusing on each word in turn to detect any mispronunciations.
2. For each word that is mispronounced, there are several alternatives to get the correct pronunciation.
 - a. For words that have two alternate pronunciations, and DECtalk has chosen the wrong one, try placing a right parenthesis in front of the spelling, which asks for the second pronunciation. (See Section 7.6.10 and Appendix D, which contains a complete list of words for which two pronunciations are known to DECtalk.)

I)read yesterday that . . .

- b. Replace the correct spelling of the word with a clever misspelling (Section 7.3).

I red yesterday that . . .

- c. If the word is a compound, use a hyphenated spelling to help DECtalk see the two parts of the compound (Section 7.6.9).

The slide-show host . . .

- d. Replace the text version by a phonemic string. Use the commands and phonemic symbols described in Section 7.5. Be sure to place the lexical stress pattern correctly (Section 7.6). For example, you can replace the word "Alphonse" with [aelf'aans].

3. Sometimes, a word does not sound quite right even when the best alternate phonemic representation is selected. Usually, such subtle pronunciation defects are not correctable. However, if they are due to incorrect phoneme durations, then you can specify the duration of each phoneme with the commands described in Section 7.7.1. This process is difficult and probably should not be tried until you have mastered the other steps described here.
4. Now that each word has been pronounced in the best possible way, listen to the total sentence rhythm and accent pattern. If it is not right, try each of the following steps.
5. If it sounds like there should be a short pause in a particular sentence location, but DECtalk says the sentence without a pause, try inserting a comma between the words in question (Section 7.6.11.).
6. If the comma makes a pause that is too noticeable, try a phonemic verbphrase-boundary symbol instead (Section 7.6.10.).

The old man [)] stares at everyone.

7. If the wrong word is emphasized in the sentence, try to point out the word that should receive most emphasis by placing a phonemic emphasis symbol before it (Section 7.6.3.).

The [']old man is the trouble maker, not the younger one.

8. Use the pitch control symbols [/], [\], and [^] to make final adjustments.
9. If none of these steps gives you a satisfactory sentence, you can still specify durations and fundamental frequency motions for all phonemes with the commands described in Section 7.7. To avoid too much trial-and-error effort, you should have access to a speech analysis facility to analyze a recording of the way the sentence should sound.

For help with these steps, call your Digital sales representative for the names of people who perform text optimization and exceptions dictionary development.

10.4 COMMON ERRORS

When using DECtalk, try to avoid making these two common, major errors.

1. Forgetting to change back to default voice

If you forget to return DECtalk to the standard Paul voice after using one of the other voices, all future text will use the voice currently selected. It is a good programming habit to return to Paul's voice after every text message.

2. Accidental entry into phonemic mode

If `MODE_SQUARE` is on, permitting phonemic input, then it is possible to get into phonemic mode unintentionally. If the text contains an unexpected `[`, or if you forget to type `]` after a phonemic entry, DECtalk is left in a state where it tries to interpret text phonemically. This error makes DECtalk garble speech. In fact, DECtalk is simply doing the best it can to interpret text phonemically, discarding phonemically illegal letters. DECtalk keeps track of the number of extra `[` symbols in the input relative to the number of `]` symbols it has seen. If text happens to have one or more extra `[` symbols, you may need to type several `]` symbols to get DECtalk out of phoneme-input mode.

APPENDICES

Appendix A	DECTalk Escape Sequences, Status Replies, and Parameters	146
Appendix B	Configuring the DECTalk Module	154
Appendix C	Abbreviations and Acronyms	159
Appendix D	Words with Two Pronunciations	173
Appendix E	DECTalk/Dictionary Phonemic Correspondence	177
Appendix F	Text Tuning Example	182
Appendix G	Basic Program Example	185
Appendix H	Service and Documentation	191

A DECTalk ESCAPE SEQUENCES, STATUS REPLIES, AND PARAMETERS

This appendix summarizes the DECTalk escape and control sequences, status replies, and their parameters described in this manual. The following tables list escape sequence mnemonics and their ASCII representations and parameters.

You can verify each ASCII character by checking the decimal value that appears below the character.

Table A-1 Escape Commands

Mnemonic	Escape Sequence and Function
DA primary	<p>ESC [c 027 091 099</p> <p>Request DECTalk to identify itself. See Table A-2 for reply.</p>
DA secondary	<p>ESC [> c 027 091 062 099</p> <p>Request DECTalk to identify its hardware/firmware version.</p>
DECSCCL	<p>ESC [P1 ; P2 " p 027 091 *** 059 *** 034 112</p> <p>Select device conformance level (1 or 2) and C1 control transmit format (Section 5.1).</p>
DECSTR	<p>ESC [! p 027 091 033 112</p> <p>Soft reset to power-up state.</p>
DECTST	<p>ESC [5 ; P2 y 027 091 053 059 *** 121</p> <p>Perform a self-test (Section 5.3).</p>
DSR brief	<p>ESC [5 n 027 091 053 110</p> <p>Give a brief status report. See Table A-2 for replies.</p>
DSR extended	<p>ESC [n 027 091 110</p> <p>Give an extended device status report. See Table A-2 for replies.</p>
DT_DICT	<p>ESC P 0 ; 4 0 z name SP phoneme ESC \ 027 080 048 059 052 048 122 ***** 032 ***** 027 092</p> <p>Load user dictionary. See Table A-2 for replies.</p>

Table A-1 Escape Commands (Cont.)

Mnemonic	Escape Sequence and Function
DT_INDEX	<p>ESC P 0 ; 2 0 ; P3 z ESC \ 027 080 048 059 050 048 059 *** 122 027 092</p> <p>Insert index flag in text. P3 range is 0 to 32767 (sent as ASCII characters).</p>
DT_INDEX_ QUERY	<p>ESC P 0 ; 2 2 z ESC \ 027 080 048 059 050 050 122 027 092</p> <p>Request DECTalk to return last index marker spoken. See Table A-2 for reply.</p>
DT_INDEX_ REPLY	<p>ESC P 0 ; 2 1 ; P3 z ESC \ 027 080 048 059 050 049 059 *** 122 027 092</p> <p>Insert index flag in text and inform the host computer. P3 range is the same as for DT_INDEX. See Table A-2 for reply.</p>
DT_LOG	<p>ESC P 0 ; 8 1 ; P3 ; P4 z ESC \ 027 080 048 059 056 049 059 *** 059 *** 122 027 092</p> <p>Control logging of phonemes corresponding to the input text back to the host computer (Section 8.10).</p>
DT_MASK	<p>ESC P 0 ; 8 3 ; P3 ; P4 z ESC \ 027 080 048 059 056 051 059 *** 059*** 122 027 092</p> <p>Control how DECTalk sends escape sequences and keypad characters to the host computer (Section 6.2).</p>
DT_MODE	<p>ESC P 0 ; 8 0 ; P3 ; P4 z ESC \ 027 080 048 059 056 048 059 *** 059*** 122 027 092</p> <p>Set DECTalk mode of operation (Section 4.6.2).</p>
DT_PHONE	<p>ESC P 0 ; 6 0 ; P3 z ESC \ 027 080 048 059 054 048 059 *** 122 027 092</p> <p>Control attached telephone and telephone keypad interface (Section 6.1).</p>

Table A-1 Escape Commands (Cont.)

Mnemonic	Escape Sequence and Function
DT_ PHOTEXT	ESC P 0 ; 0 z ESC \ 027 080 048 059 048 122 027 092 Speak phonemic text.
DT_SPEAK	ESC P 0 ; 1 2 ; P3 z ESC \ 027 080 048 059 049 050 059 *** 122 027 092 Enable (P3 ≠ 0) or disable (P3 = 0) speaking.
DT_STOP	ESC P 0 ; 1 0 z ESC \ 027 080 048 059 049 048 122 027 092 Stop speaking and dump any pending unspoken text.
DT_SYNC	ESC P 0 ; 1 1 z ESC \ 027 080 048 059 049 049 122 027 092 Finish speaking current text before processing next command.
RIS	ESC c 027 099 Hard reset to power-up state with return to level 2 and default character set selection.
S7C1T	ESC SP F 027 032 070 Select 7-bit C1 control character transmission.
S8C1T	ESC SP G 027 032 071 Select 8-bit C1 control character transmission. Ignored if host communications line is set for 7 bits.

Table A-2 DECTalk Status Replies

Mnemonic	Escape Sequence and Function
DT_DICT	ESC P 0 ; 5 0 ; P3 z ESC \ 027 080 048 059 052 048 059 *** 122 027 092

P3 parameters are as follows.

0	Word was entered correctly.
048	

1	No room is in dictionary.
049	

2	Entry is too long.
050	

DA primary	ESC [? 8 2 ; 2 ; 3 c 027 091 063 056 050 059 050 059 051 099
------------	---

Reply from DECTalk to DA primary sequence.

DA secondary	ESC [> P1 ; P2 ; P3 c 027 091 062 *** 059 *** 059 *** 099
--------------	---

P1, P2, and P3 parameters are as follows.

P1	1 2	Hardware identification code
	049 050	

P2	1 0	Firmware revision number
	049 048	(times 10)

P3	1	Spoken language (American English)
	049	

DSR brief	ESC [0 n 027 091 048 110
-----------	-------------------------------------

No malfunctions occurred.

	ESC [3 n 027 091 051 110
--	-------------------------------------

Malfunction occurred.

Table A-2 DECTalk Status Replies (Cont.)**Mnemonic Escape Sequence and Function**

DSR **ESC [0 n ESC [? 2 1 n**
 extended 027 091 048 110 027 091 063 050 049 110

No malfunctions occurred. First reply since the unit was powered up.

ESC [0 n ESC [? 2 0 n
 027 091 048 110 027 091 063 050 048 110

No malfunctions; subsequent replies.

ESC [3 n ESC [? P1 ; Pn n
 027 091 051 110 027 091 063 *** 059*** 110

Malfunction occurred. P1 through Pn parameters are as follows.

2 2 Communication failed.
 050 050

2 3 Input buffer overflowed.
 050 051

2 4 Last NVR operation failed.
 050 052

2 5 Error is in phonemic transcription.
 050 053

2 6 Error is in DECTalk private control
 sequence.
 050 054

2 7 Last DECTST failed.
 050 055

DT_INDEX_ **ESC P 0 ; 3 2 ; P3 z ESC **
 QUERY 027 080 048 059 051 050 059 *** 122 027 092

P3 is the ASCII value of the last index spoken.

Table A-2 DECTalk Status Replies (Cont.)**Mnemonic Escape Sequence and Function**

DT_INDEX_ **ESC P 0 ; 3 1 ; P3 z ESC **
REPLY 027 080 048 059 051 049 059 *** 122 027 092

Reply sent by DECTalk after speaking indexed text.
P3 is the ASCII value of the last index spoken.

DT_PHONE_ **ESC P 0 ; 7 0 ; P3 z ESC **
REPLY 027 080 048 059 055 048 059 *** 122 027 092

Reply sent by DECTalk after executing DT_PHONE command
(specifying telephone status).

P3 parameters are as follows.

0 048	Telephone is on the hook (hung up).
1 049	Telephone is off the hook (active).
2 050	Keypad timeout.
3 051	Dial entry is too long (over 256 characters).
4 052	Wink detected.
5 053	No dial tone.
6 054	Telephone is busy.
7 055	No answer (a long timeout).

Table A-3 Conformance Level and C1 Format Setting Parameters

Parameter	ASCII Code	Function
P1	8 1 056 049	Select level 1 conformance (local terminal).
	8 2 056 050	Select level 2 conformance (wink detection and call progress detection).
C1	0 048	Select default 8-bit (7-bit and ignored parity) format.
	1 049	Select 7-bit format.
	2 050	Select 8-bit format.

Table A-4 Dialing Characters

Characters	Function
0123456789	Normal digits.
★#ABCD	Used in Touch-Tone (DTMF*) dialing; ignored in interrupted pulse dialing.
!	Pause for 1 second.
^	Switch-hook flash for 250 milliseconds.
W	Wait for dial tone.
X	Wait for answer.
P	Switch dialing mode to interrupted pulse.
T	Switch dialing mode to Touch-Tone (DTMF).

* DTMF is the dual tone multiple frequency signaling technique.

B CONFIGURING THE DECTalk MODULE

This appendix shows how to configure and test a DECTalk module (C5005).

B.1 SETTING THE CONFIGURATION SWITCHES

The DECTalk module has an eight-position DIP switchpack. See Figure B-1 for the DIP switch settings that determine the required serial line speed, data format, and keypad mask power-up status.

If necessary, change the switch settings according to the switch position lists in Sections B.1.1 through B.1.4.

CAUTION: Use a ballpoint pen, a small screwdriver, or the equivalent to set the switches. Never use a lead pencil.

The default (factory) switchpack setting provides for 9600 baud, 7 data bits, ignore parity, and the keypad mask set to all 0s. In the default setting, all switches are off as shown on Figure B-1.

NOTE: Switch positions are on (closed) and off (open).

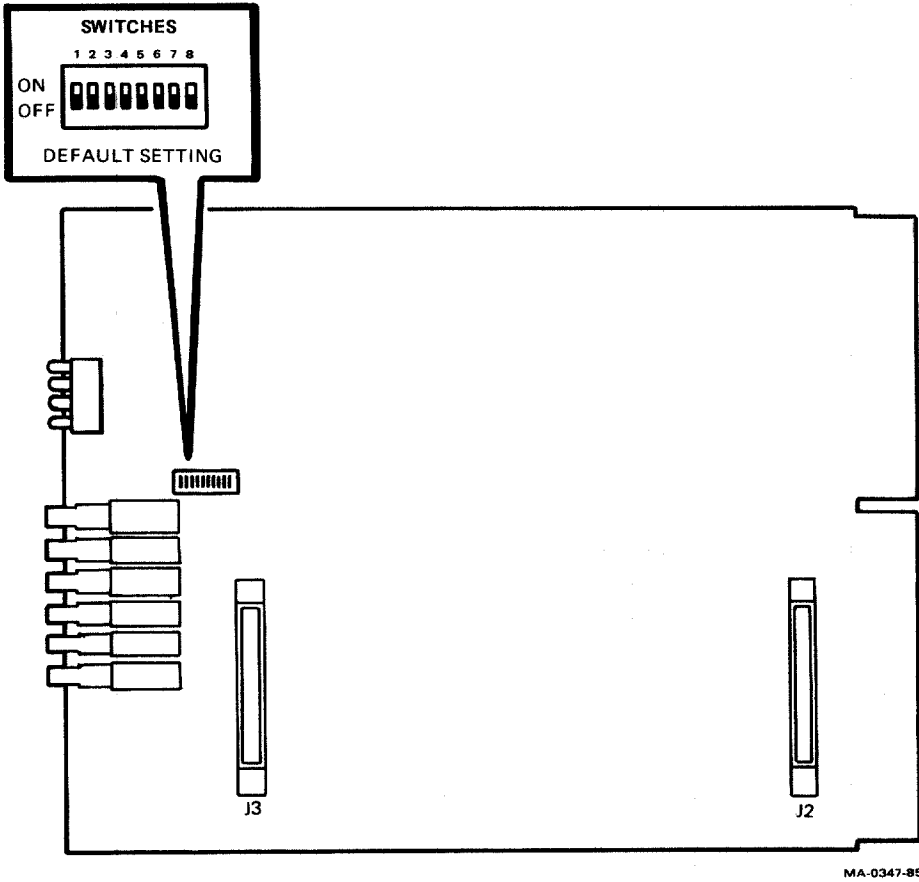

Figure B-1 DIP Switchpack Settings

B.1.1 Line Speed

Switches SW6, SW7, and SW8 set the data speed on the EIA RS232-C line as follows.

SW6	SW7	SW8	Function (baud)
Off	Off	Off	9600
Off	Off	On	4800
Off	On	Off	2400
Off	On	On	1200
On	Off	Off	600
On	Off	On	300
On	On	Off	150
On	On	On	110

NOTE: DECTalk uses one stop bit at all speeds except 110 baud, when it uses two stop bits.

B.1.2 Data Format

Switches SW4 and SW5 are used to set the data format on the EIA RS232-C line as follows.

SW4	SW5	Function
Off	Off	7 bits, ignore parity
On	On	7 bits, odd parity
On	Off	7 bits, even parity
Off	On	8 bits, no parity

B.1.3 Keypad Mask

Switch SW3 determines the power-up default setting of the keypad mask.

SW3	Function
Off	All 0s at power-up
On	All 1s at power-up

NOTE: Switch SW2 is not used.

B.1.4 Busyout

Switch SW1 determines if the DM pushbutton on the front panel is enabled.

SW1	Function
Off	DM disabled
On	DM enabled

B.2 TESTING THE MODULE

To test a module, perform the routine self-test as follows.

1. On the module you are checking, press the DL, CL, and ST pushbuttons *in that order* (Figure B-2).

The LEDs on the module light for about 0.5 seconds, then go off for 1 second, and the SP LED flashes a few times.

2. If the module passes the test, the OK LED lights continuously.

If the module fails the test, the LEDs flash or stay off. Call Digital's Field Service.

3. The module repeats this test every 15 seconds as long as the ST pushbutton is down. To stop the test, release the ST, DL, and CL pushbuttons *in that order*. If the module passes the test, it comes up ready to operate.

NOTE: Remember to release the ST, DL, and CL pushbuttons or the module will continue to run the self-test.

APPENDIX B

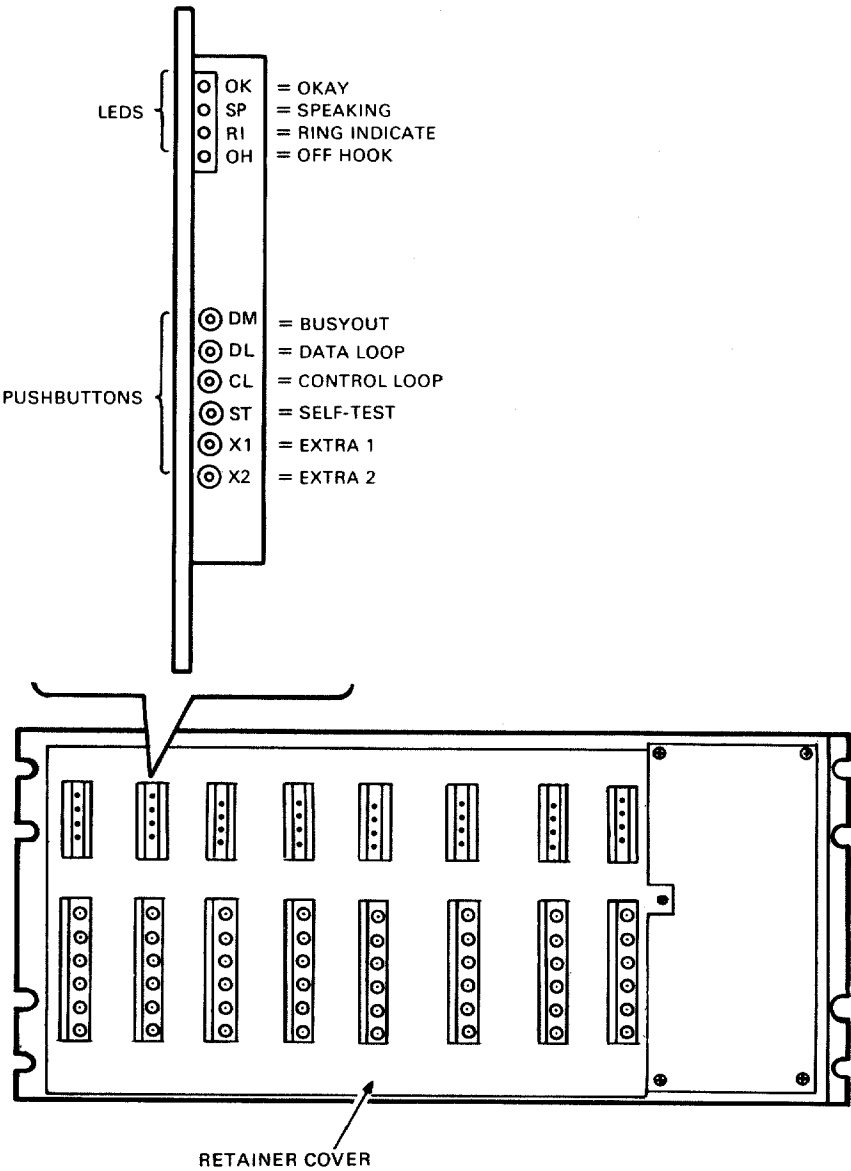

MA-0359-85

Figure B-2 DECtalk Module Controls

ABBREVIATIONS AND ACRONYMS

C

This appendix describes how DECtalk processes numbers, abbreviations, and acronyms, and how it decides whether a word is pronounceable. It also includes suggestions for correcting spoken output problems.

C.1 TEXT PROCESSING RULES

DECtalk processes text to be spoken by applying the following rules in this order.

1. The input text stream is broken into groups of letters delimited by white-space characters (spaces, tabs, or carriage returns).
2. If the letter string is not already phonemic text and is to be converted, any understandable numbers are first expanded to their word equivalents.

3. Some abbreviations are expanded to their full-word equivalents. DECtalk uses a list of numeric abbreviations and rules for a few special cases. The user dictionary cannot override this conversion.
4. Each letter string is broken into pronounceable entities. Punctuation (including parentheses and quotation marks), hyphenated words, and sequences that must be spelled out are analyzed. Some abbreviations and acronyms are recognized, plus any entries from the user dictionary.
5. Any text that DECtalk recognizes as unpronounceable (for example, a sequence of letters containing no vowels) is spelled out.

A few rules operate on sequences of words. Interspersing phonemic symbols or DECtalk commands (certain escape sequences, for example) will block these rules. Therefore, make sure that spoken text is as contiguous as possible and keep breaks in structure (from English spelling to phonemic transcription) to a minimum.

The following terms are used in this appendix.

Character	Any of the printable ASCII characters, including letters, digits, and punctuation.
Digit string	A string of digit characters (0 through 9). DECtalk decides whether these should be pronounced as numbers or independent characters.
Number	A string of characters (containing digits) that are processed as a group by DECtalk. For example, "123" is pronounced "one hundred and twenty-three," while "1(2)3" is pronounced "one left-parenthesis two right-parenthesis three."

C.2 NUMBER PROCESSING

DECtalk recognizes seven general number classes, and a large number of special cases and subclasses. The general classes are as follows.

Part numbers	Strings of mixed letters, digits, and the - and / characters.
Cardinal numbers	The simple numbers that are used in counting. Examples include "123," "123,456," "12.345," "01234," "+1.2E-4," and "12%."
Ordinal numbers	Simple strings of numbers with "st," "nd," "rd," or "th" added, for example, "1st" and "23rd."
Fractions	Examples are "1/2," "2/3," and "44/100%."
Money	Recognized by the presence of a dollar sign (\$) or a pound sign (£) as the first character of a word.
Dates	In Digital's standard format (23-Sep-1983), and expandable into their English equivalent.
Time of day	In the 24-hour format used by the VAX/VMS operating system (11:04:03.02), and is spoken in its English equivalent. The words "AM" and "PM" are correctly processed after time values.

C.2.1 Part Numbers

A part number is defined as a string of mixed letters, digits, and the - and / characters, containing at least one digit. The following are examples of part numbers.

DTC03-AA
 VAX-11/780
 54-15966-01

DECtalk first attempts to find the part number in the user and built-in dictionaries. If it is unsuccessful, DECtalk breaks the part number into strings of letters, strings of digits, and separators.

A series of words separated by / is spelled out. DECtalk correctly speaks part numbers of the format XXX/YYYY. However, it will not recognize words such as "Raleigh/Durham" unless they are stored in the user dictionary.

A string of digits within a part number is spoken as follows.

1. If the digit string begins with 0 or is more than nine digits long, it is spelled out ("VS01" becomes "vee ess zero one").
2. One- or two-digit strings are spoken as normal cardinal numbers ("PDP-11" becomes "pee dee pee dash eleven").
3. Three- or four-digit strings that end with 00 are spoken as normal cardinal numbers ("VT100" becomes "vee tee one hundred").
4. Other three-digit strings are spoken as "digit, pair of digits" ("VT220" becomes "vee tee two twenty").
5. Other four-digit strings are spoken as "pair, pair" ("DEC 2040" becomes "deck twenty forty"). Note that if the second pair begins with 0, it is pronounced "zero" ("IBM 1401" becomes "eye bee em fourteen zero one").

An alphabetic string is spoken as follows.

1. One- or two-character strings are spelled out ("VT100" becomes "vee tee one hundred").
2. Longer strings are searched for in the user and built-in dictionaries. If they are not found, they are spelled out ("DEC 2040" becomes "deck twenty forty").

DECtalk cannot handle all possible part numbers perfectly. The following examples of part numbers are inconsistent with DECtalk's number and text processing algorithms.

CICS/VS	Not a part number – no digits.
net10000	“Net” is spelled out since it isn’t in the dictionary.
1E-14	DECtalk thinks this number is scientific notation.

When processing numbers and number words, DECtalk first removes leading and trailing punctuation. DECtalk translates “(123)” as “one hundred and twenty-three.”

C.2.2 Cardinal Numbers

A cardinal number is a string of digits. If commas are included, they must break numbers into groups of three. For example, “123,456” is correct, but “1234,56” is not. The latter will be spelled out as “one two three four comma five six.”

Cardinal numbers may also include decimal fractions (“12.34”) and scientific notation (“12.34E56”). In scientific notation, the exponent must be less than 100.

A cardinal number preceded by + or – will be spoken as “plus” or “minus” whether or not MODE_MINUS is on (Section 4.6.2).

If the first digit is 0 (“01234”), the number will be spoken as a string of digits as would be appropriate when reading postal zip codes.

If the number is greater than 999,999,999, it will be spoken as a string of digits with pauses between each group of three digits. If commas are provided, they will control the pause behavior. If not, the output will pause after each group of three digits, provided six or more digits remain. Therefore, “12345678901” will be spoken as “123, 456, 78901” rather than “12,345,678,901.”

Four-digit numbers without commas are spoken in a variety of formats. For example, “5000” becomes “five thousand,” while “1984” becomes “nineteen eighty-four.” This yields reasonable behavior when processing years.

Sometimes DECtalk does not understand the text well enough to pronounce the number correctly. Here are some examples.

- The telephone number "(617) 493-8255" will be spoken as "six hundred and seventeen, four ninety three dash eight two five five." You can correct this by using one of the following steps.

Spell out the digits as "six one seven, four nine three, eight two five five" (notice the commas to make DECtalk pause at appropriate places).

Separate the digits with spaces and commas: "6 1 7, 4 9 3, 8 2 5 5."

- The software cannot easily distinguish between "dash" and "minus."

How much is 10-15?

Bake this 10-15 minutes.

The `MODE_MINUS` option mode (Section 4.6.2) determines whether the - is pronounced as "dash" or "minus."

Some number formats are difficult to recognize out of context. For example, the International Standard Date format (83.09.20) and the United States telephone number format (noted previously) are sometimes used by manufacturers for part numbers. These ambiguous formats are not recognized by DECtalk and you must correct them.

After a cardinal number, DECtalk recognizes a set of standard numeric abbreviations that are expanded to their English equivalent. These abbreviations are hardwired into DECtalk and cannot be modified by the applications programmer. DECtalk correctly generates singular and plural forms of these abbreviations.

Table C-1 lists the numeric abbreviations recognized by DECtalk after a cardinal number. You can write them in either uppercase or lowercase letters, but you must follow them by a period, as the table shows.

Other abbreviations, such as "cc.," are spelled out by DECtalk. The period that follows such an abbreviation is *not* pronounced ("cc." becomes "see see") but terminates the clause, while the period in number abbreviations does not terminate the clause.

Table C-1 Numeric Abbreviations Recognized by DECTalk

Abbreviation	Word	Abbreviation	Word
Length and Distance			
cm.	centimeter(s)	m.	meter(s)
ft.	foot (feet)	mi.	mile(s)
in.	inch(es)	mm.	millimeter(s)
ins.	inches	yd.	yard(s)
km.	kilometer(s)	yds.	yards
Area			
ha.	hectare(s)		
Volume			
l.	liter(s)	tsp.	teaspoon(s)
ml.	milliliter(s)	tbsp.	tablespoon(s)
qt.	quart(s)		
Mass, Weight			
g.	gram(s)	lbs.	pounds
gm.	gram(s)	mg.	milligram(s)
kg.	kilogram(s)	oz.	ounce(s)
lb.	pound(s)	ozs.	ounces
Time			
hr.	hour(s)	sec.	second(s)
msec.	millisecond(s)	secs.	seconds
min.	minute(s)	usec.	microsecond(s)
nsec.	nanosecond(s)		
Miscellaneous			
deg.	degree(s)	kts.	knots
kt.	knot(s)		

C.2.3 Ordinal Numbers

Ordinal numbers are formed from a string of digits (that may contain appropriate commas) followed by "st," "nd," "rd," or "th." Ordinal numbers are also generated by DECTalk when fractions and dates (in standard Digital format) are processed.

DECTalk requires that the word portion of the ordinal number be correct. For example, "1st" will be processed correctly, but "2th" will not.

C.2.4 Fractions

Fractions consist of one or two digits in the numerator, the / character, and one to three digits in the denominator. The numerator may range from 1 to 99, while the denominator may range from 1 to 100. DECTalk correctly generates singular (1/3) and plural (2/3) forms.

Fractions can also use the ordinal abbreviations described in Section C.2.3, for example, "2/3rds."

C.2.5 Money

DECTalk assumes a digit string is money when it is introduced by the currency symbols \$ or £.

When the \$ or £ is recognized, DECTalk allows two forms of number strings.

- General digit strings have optional decimal fractions ("12.345").
- Digit strings are in dollars and cents (or pound and pence) format ("12.34").

DECTalk recognizes a number of quantity words (hundred, thousand, million) that modify number processing if they immediately follow the money word. For example, "\$1.23" million is pronounced "one point two three million dollars."

C.2.6 Dates

DECtalk recognizes dates written in Digital's standard date format, such as "23-Sep-1983," "23-Sep," or "23-Sep-83." However, it will pronounce "Sep. 23, 1983" as "September twenty-three, ninteen eighty-three."

C.2.7 Time of Day

DECtalk recognizes the time of day when written in the format used by Digital operating systems. Because this format can easily be confused with part number formats, DECtalk does not try to convert the digit string. Instead, it speaks the string with appropriate punctuation. Therefore, "12:00" becomes "twelve, zero zero," rather than "twelve noon."

DECtalk correctly processes VAX/VMS time values, including the fractional second value when it is present.

C.3 ABBREVIATIONS

DECtalk recognizes, expands, and selects from a set of abbreviations taking into the account that the abbreviations may be ambiguous.

C.3.1 Abbreviations Processed by DECtalk

In addition to the abbreviations that are recognized only after cardinal numbers, DECtalk recognizes two special cases, "Dr." and "St." The pronunciation of these abbreviations depends on whether the next word is capitalized.

- If the next word is not capitalized or if there is no next word (the clause has ended), then "Dr." is pronounced "drive" and "St." is pronounced "street." The next word must be on the same input line for the rule to work correctly.
- If the next word is capitalized, then "Dr." is pronounced "doctor" and "St." is pronounced "saint."

Following these rules, DECtalk correctly pronounces "Doctor Dobbs Drive" and "Saint Louis Street" in running text.

C.3.2 Abbreviations in the Built-In Dictionary

Table C-2 lists the abbreviations stored in the built-in dictionary. Some of these abbreviations are also in Table C-1.

If the abbreviation can be recognized by DECtalk during number processing, then the English text form of the abbreviation is spoken. Otherwise, the built-in dictionary form is spoken. Abbreviations stored in the user dictionary override those in the built-in dictionary. The numeric abbreviations can be blocked by including a dummy phonemic string, for example, "1 []ft. 3."

Dictionary entries that contain only uppercase letters, match text words that contain uppercase letters in the same positions. However, the entries that contain only lowercase letters, may match text words that contain either lowercase or uppercase letters in the same positions.

"Apr." matches "APR." but not "apr." This is necessary to distinguish between words at the end of a sentence and valid abbreviations, such as "mar" (to damage) and "Mar." (for March).

If a word in Table C-2 is written with a terminating period, you must include that period in the input text. (It will not terminate the current clause.)

Table C-2 Abbreviations Recognized by DECtalk

Abbreviation	Word	Abbreviation	Word
all-in-1	All in one	COD	"see-oh-dee"
all-in-one	All in one	cont.	continued
Apr.	April	Corp.	corporation
Assoc.	Associates	Ctr.	center
Aug.	August	CTRL.	control
Av.	Avenue	cu.	cubic
Ave.	Avenue	dec	DEC (as in Digital)
bldg.	building	Dec.	December
Blvd.	Boulevard	Dist.	district
CH.	Chapter	deg.	degrees
Ch.	Chapter	Dept.	Department
cm.	centimeters	doz.	dozen
cms.	centimeters	Dr.	Doctor or Drive*
Co.	Company	e.g.	E G (not for example)

Table C-2 Abbreviations Recognized by DECtalk (Cont.)

Abbreviation	Word	Abbreviation	Word
ESC	escape	msec.	milliseconds
esp.	especially	msecs.	milliseconds
est.	established	mss.	manuscripts
etc.	et cetera	Mt.	Mount
ext.	extension	Nov.	November
Feb.	February	nt.wt.	net weight
fig.	figure	Oct.	October
Flt.	flight	op.cit.	op cit
FOB	freight on board	oz.	ounces
fn.	footnote	ozs.	ounces
Fr.	Father	p.p.d.	post paid
Fri.	Friday	pat.pend.	patent pending
ft.	feet (not foot)	Pl.	Place
Ft.	Fort (not Foot)	pp.	pages
Gen.	General	ppd.	post paid
gm.	grams	Pres.	President
Gov.	Governor	Rd.	Road
hrs.	hours	recd.	received
i.e.	I E (not that is)	Rep.	Representative
Inc.	Incorporated	Rev.	Reverend
Intl.	international	rsts	"ris-tis"
Jan.	January	rsts/e	"ris-tis-ee"
Jr.	Junior	Rte.	route
Jul.	July	Sat.	Saturday
Jun.	June	Sen.	Senator
kg.	kilograms	Sep.	September
kgs.	kilograms	Sept.	September
km.	kilometers	sq.	square
lb.	pounds	Sr.	Senior
lbs.	pounds	St.	Saint or Street*
Ltd.	Limited	Sun.	Sunday
Mar.	March	Thu.	Thursday
mg.	milligrams	Thurs.	Thursday
mgs.	milligrams	Tue.	Tuesday
misc.	miscellaneous	Tues.	Tuesday
ml.	milliliters	Univ.	University
Mon.	Monday	USA	"you-ess-aye"
mr.	mister	Vol.	Volume
mrs.	missus	vs.	versus
ms.	miz	Wed.	Wednesday
msde.	merchandise	yds.	yards

* See Section C.3.1.

C.4 WORD SPELLOUT STRATEGIES

After number processing, DECTalk must decide whether to pronounce a string of characters as a single word or a compound word, or if it must be spelled out. DECTalk uses the built-in and user dictionaries and a series of word transformations to make this decision.

C.4.1 Word Spellout Tests

Number conversion, number abbreviations, and the "Street/Saint" test have all been performed before DECTalk begins the decision tests. Punctuation has not yet been removed.

1. DECTalk looks for the word in the dictionaries. First the user dictionary is scanned, then the built-in dictionary. (Note that the user dictionary takes precedence. If the word is found in that dictionary, the search stops.)

The dictionary lookup procedure involves stripping suffixes such as "-ed" and "-ing." If the word is found in the dictionary, DECTalk speaks the associated phonemic transcription.

2. If the word is not found, any punctuation around the word is removed. If present, the punctuation symbols " ([« < [are removed from the front of the word, and the punctuation symbols ") » >] are removed from the end of the word. The square brackets [] are already discarded if MODE_SQUARE is on.
3. If some punctuation was removed, DECTalk performs a special test for abbreviations "(Gen.)" and embedded sentence punctuation ("I went (last year?) to school").
4. Next, DECTalk looks for initialisms. (An initialism is a word written as a string of uppercase letters that may or may not be separated by ".") For example, the string "APO" is pronounced as "aye pea oh." Other strings with embedded periods are spelled out. Therefore, "a.p.o." would be pronounced as "aye period pee period oh period."

If an initialism is recognized, the last "." will terminate the clause, unless it is followed by some other punctuation.

5. At this point, all diacritical marks are removed.
6. If the word is still not found, it is examined for hyphenation (as in compound nouns) and the single-quote character. A test is also performed to make sure any word or word fragment has enough consonants and vowels. If the test fails, the word is spelled out.

This test ensures that the word does not contain embedded punctuation. A word like "sys\$system" is spelled out.

7. If DECtalk decides the word is pronounceable, it processes each part of a compound noun independently. If the word is not in the dictionary, it is processed by the letter-to-sound rules.
8. If the word was pronounced, DECtalk examines the punctuation after the word for silence or clause terminators. The punctuation marks ")] } produce a brief silence (only one silence is produced, even if several characters are processed). The punctuation marks ; : ! , . ? terminate a clause.
9. If DECtalk decides that the word must be spelled out, the entire word is spelled, including left and right punctuation. If the last letter of the word is a clause terminator, it is considered punctuation and is not spelled.
10. A single letter, digit, or other character within quotes or parentheses is spelled out (but the punctuation isn't spoken). "A" is pronounced ['ey] rather than "uh." This helps DECtalk process lists such as the following.
 - (a) books
 - (b) newspapers
11. Brackets, parentheses, and braces act as commas, producing a clause boundary. Therefore, parenthetical expressions (such as this one) sound more natural.
12. When text is spelled out, a brief pause is added after each character. This makes it easier to transcribe text, such as part numbers.

C.4.2 Multinational Characters

DECtalk pronounces the names of all multinational characters. Note that this does not mean that DECtalk will correctly pronounce words from other languages, such as “Tromsø,” “doña,” and “garçon.” For example, “doña” would be pronounced [d’ownax], but ñ would be pronounced “en tilde.”

The Digital character sets are described in Chapter 4 of this manual.

WORDS WITH TWO PRONUNCIATIONS **D**

Table D-1 provides a list of homographs. Homographs are pairs of words that are spelled exactly the same but are pronounced differently. Usually, they are noun-verb pairs like insert (noun: stress on first syllable) and insert (verb: stress on second syllable), although adjective-verb and verb-verb pairs do occur. In earlier versions of DECtalk, the default form was always the noun. Here, however, the default form is the more frequent form of the two. The pronunciation of "transform" as a verb (second syllable stressed) is more common than that of the noun (first syllable stressed) and therefore the verb is the default.

If DECtalk gives one pronunciation for a word in this list and you want the alternative pronunciation, simply type a right parenthesis) (no space) before the word.

For example, if you type "bass," DECtalk will say [b'ays] (the voice lower than baritone). However, if you want the alternate pronunciation, you should type ")bass" and DECtalk will say [b'aes] (a type of fish).

Table D-1 Words with Alternate Pronunciations

Word	Default Pronunciation	Alternate Pronunciation Using)
abstract	'aebstraekt	aebstr'aekt
abuse	axby'uz	axby'us
addict	axd'ihkt	'aediht
advocate	'aedvaxkeyt	'aedvaxkaxt
affix	'aefihks	axf'ihks
alternate	'aoltrrnaxt	'aoltrrneyt
animate	'aenihmeyt	'aenihmaxt
annex	'aenehks	axn'ehks
appropriate	axpr'owprijaxt	axpr'owprijeyt
associate	axs'owshiyeyt	axs'owshiyaxt
attribute	axtr'ihbyxuwyt	'aetrixbyxuwyt
august	'aogaxst	aog'ahst
bass	b'es	b'aes
close	kl'owz	kl'ows
combat	kaxmb'aet	k'aambaet
combine	kaxmb'ayn	k'aambayn
compact	kaxmp'aekt	k'aampaekt
compound	kaxmp'awnd	k'aampawnd
compress	kaxmpr'ehs	k'aamprehs
conduct	kaxnd'ahkt	k'aandahkt
content	k'aanteht	kaxnt'ehnt
conflict	k'aanflihkt	kaxnfl'ihkt
console	k'aansowl	kaxns'owl
construct	kaxnstr'ahkt	k'aanstraxkt
contest	k'aanteht	kaxnt'ehst
contract	k'aantraekt	kaxntr'aekt
contrast	k'aantraest	kaxntr'aest
converse	k'aanvrrs	kaxnv'rrs
convert	kaxnv'rrt	k'aanvrrt
convict	kaxnv'ihkt	k'aanvihkt
coordinate	kow'aordeneyt	kow'aordixnaxt
defect	daxf'ehkt	d'iyfehkt
deliberate	daxl'ihbrraxt	daxl'ihbrrreyt
desert	d'ehzrrt	dixz'rrt
digest	d'ayjheht	dayjh'ehst
discharge	dixsch'arjh	d'ihsharjh
dove	d'owv	d'ahv
duplicate	d'uwplixkeyt	d'uwplixkaxt
elaborate	axl'aebrraxt	axl'aebrrreyt
estimate	'ehstixmeyt	'ehstixmaxt

Table D-1 Words with Alternate Pronunciations (Cont.)

Word	Default Pronunciation	Alternate Pronunciation Using)
excuse	ixksky'uz	ehksky'us
exploit	ixkspl'oyt	'ehksployt
export	ehksp'ort	'ehksport
extract	ehkstr'aekt	'ehkstraekt
implant	ihmpl'aent	'ihmplaent
import	'ihmport	ihmp'ort
imprint	'ihmprihnt	ihmpr'ihnt
incense	ixns'ehns	'ihnsehns
incline	ixnkl'ayn	'ihnklayn
increase	ihnkr'iys	'ihnkriys
insert	ihns'rrt	'ihnsrrt
insult	ihns'ahlt	'ihnsaxlt
interchange	'ihntrrcheynjh	ihntrrch'eynjh
intimate	'ihntaxmaxt	'ihntaxmeyt
invalid	ixnv'aelixd	'ihnvaxlixd
lead	l'iyd	l'ehd
live	l'ihv	l'ayv
miscount	m'ihskawnt	mihsk'awnt
misuse	mixs'yuz	mixs'yus
moderate	m'aadrraxt	m'aadreyt
object	'aabjheht	axbjh'ehkt
overrun	'owvrrrahn	owvrrr'ahn
perfect	p'rrfixkt	prrr'ehkt
permit	prrm'ihnt	p'rrmiht
pervert	prrv'rrt	p'rrvrrt
polish	p'aalihsh	p'owlixsh
predicate	pr'ehdixkeyt	pr'ehdixkaxt
predominate	prixd'aamixneyt	prixd'aamixnaxt
present	priyz'ehnt	pr'ehzaxnt
proceed	praxs'iyd	pr'owsiyd
produce	praxd'uws	pr'aaduws
progress	pr'aagrehs	praxgr'ehs
project	pr'aaajhehkt	praxjh'ehkt
protest	pr'owtehst	pr'owt'ehst
read	r'iyd	r'ehd
rebel	r'ehbel	rixb'ehl
recall	rixx'aol	r'iykaol
recap	riyk'aep	r'iykaep
recess	r'iysehs	riys'ehs
record	r'ehkrdd	rixx'ord

Table D-1 Words with Alternate Pronunciations (Cont.)

Word	Default Pronunciation	Alternate Pronunciation Using)
recount	riyk'awnt	r'iycawnt
refill	r'iyfihl	riyf'ihl
refresh	riyfr'ehsh	r'iyfrehsh
refund	riyf'ahnd	r'iyfahnd
refuse	rixf'yuz	r'ehfyus
reject	rixjh'ehkt	r'iyjhehkt
relapse	r'iylaeps	rixl'aeps
relay	r'iyley	rixl'ey
remake	r'iymeyk	riym'eyk
rerun	r'iy*rahn	riy*r'ahn
research	r'iysrrch	riys'rrech
retake	riyt'eyk	r'iyteyk
rewrite	riyr'ayt	r'iy*rayt
segment	s'ehgmixnt	sehgm'ehnt
separate	s'ehpaxreyt	s'ehpaxraxt
subject	s'ahbjhehkt	saxbjh'ehkt
sublet	s'ahbleht	saxbl'eht
subordinate	saxb'ordenaxt	saxb'ordeneyt
suspect	s'ahspehkt	saxsp'ehkt
syndicate	s'ihndixkixt	s'ihndixkeyt
tear	t'er	t'ir
torment	torm'ehnt	t'ormehnt
transform	traensf'orm	tr'aensform
transplant	traensp'l'aent	tr'aensplaent
transport	traensp'ort	tr'aensport
upset	axps'eht	'ahpseht
use	'yuz	'yus
wind	w'ihnd	w'aynd
wound	w'awnd	w'uwnd

DECtalk/DICTIONARY PHONEMIC CORRESPONDENCE **E**

Several English phonemic alphabets are widely used today. Table E-1 lists the phonemic alphabet that DECtalk uses, together with the phonemic alphabets from three well-known dictionaries. It also gives an example of each sound.

Some dictionaries put the stress symbol after the vowel nucleus or at the start of the syllable. DECtalk requires that the stress symbol appears before the vowel.

Table E-1 has been alphabetized according to the Random House Dictionary phonemes to facilitate translation of a dictionary pronunciation into DECtalk phonemes.

Table E-1 DECTalk and Dictionary Phonemic Alphabets

Random House Dictionary*	American Heritage Dictionary†	Webster's Ninth New Collegiate Dictionary‡	English Example	DECTalk Phonemic Alphabet
a	ă	a	bat	ae
ā	ā	ā	bake	ey
ä	ä	ä	father	aa
âr	âr	ar	bear	er
är	är	är	bar	ar
b	b	b	bet	b
ch	ch	ch	chin	ch
d	d	d	debt	d
e	ě	e	bet	e
ē	ē	ē	beat	iy
f	f	f	fin	f
g	g	g	gift	g
h	h	h	head	hx
hw/w	hw/w	hw	which	w
i	ī	i	bit	ih
î	î	î	bite	ay
ēr	îr	ir	beer	ir
j	j	j	gin	jh
k	k	k	cat	k
l	l	l	let	l
m	m	m	met	m
n	n	n	net	n
ng	ng	ŋ	sing	nx
ō	ō	ō	boat	ow
ô	ô	ô	bought	ao
oi	oi	oi	boy	oy
oo	oo	ù	book	uh
oo	oo	ü	lute	uw
oor	oor	úr	poor	ur
or/or	or	ór	bore	or
ou	ou	au	bout	aw

Table E-1 DECTalk and Dictionary Phonemic Alphabets (Cont.)

Random House Dictionary*	American Heritage Dictionary†	Webster's Ninth New Collegiate Dictionary‡	English Example	DECTalk Phonemic Alphabet
p	p	p	<u>p</u> in	p
r	r	r	<u>r</u> ed	r
s	s	s	si <u>t</u>	s
<u>sh</u>	sh	sh	<u>sh</u> in	sh
t	t	t	<u>t</u> est	t
<u>th</u>	th	th	<u>th</u> in	th
<u>th</u>	th	<u>th</u>	<u>th</u> is	dh
u	ū	ə	bu <u>t</u>	ah
ūr	ūr	ər	bi <u>r</u> d	rr
v	v	v	<u>v</u> est	v
w	w	w	<u>w</u> et	w
y	y	y	<u>y</u> et	yx
yōō	yōō	yu	cu <u>t</u> e	yu
z	z	z	<u>z</u> oo	z
zh	zh	zh	lei <u>z</u> ure	zh
ə	ə	ə	abu <u>t</u>	ax
ə	ə	ə	kiss <u>e</u> s	ix
ə	əl	ə	bot <u>t</u> le	el
ə ^h m	əm	ə ^h m	bot <u>t</u> om	axm
ə ^h n	ən	ə ^h n	but <u>t</u> on	en

* Reproduced by permission from the *Random House Dictionary of the English Language, Unabridged Edition*, copyright © 1983 by Random House, Inc.

† © 1981 by Houghton Mifflin Company. Reprinted by permission from the *American Heritage Dictionary of the English Language, New College Edition*.

‡ By permission. From *Webster's Ninth New Collegiate Dictionary* © 1985 by Merriam-Webster Inc., publisher of the Merriam-Webster® dictionaries.

E.1 WEBSTER'S NINTH NEW COLLEGIATE DICTIONARY

The following transformations are required in addition to those noted in Table E-1.

1. Phonemic representations that appear between backslash symbols in the dictionary should instead be enclosed in square brackets to conform with DECtalk format.

Word	Webster's	DECtalk
in	\in\	[ihn]

2. Stress marks that appear at the beginning of each syllable should be moved to appear just before the vowel.

Word	Webster's	DECtalk
bat	\'bat\	[b'aet]

3. Any syllable boundary symbol in a dictionary entry should be deleted from DECtalk phonemic pronunciations. This symbol is usually redundant information. Dictionaries are often not consistent about the use of the syllable-boundary symbol – sometimes using a syllable boundary to reflect derivational structure, and sometimes to reflect pronunciation. (A syllable boundary symbol is a legal DECtalk phoneme, but overuse or misuse of it may block application of allophone selection rules when they should apply.)

Word	Webster's	DECtalk
purser	\'pær-sər\	[p'rrsrr]
person	\'pærs-ən\	[p'rrsen]

4. The secondary stress mark may be used a bit too liberally in Webster's pronunciations. If unsure about including a secondary stress symbol that seems to be there simply to prevent vowel reduction, try listening to the word both with and without the secondary stress.

Word	Webster's	DECtalk
postulate	\'pas-chə-,let \	[p'aaschaxleyt]

5. The biggest difference with Webster's is the use of the symbol for the reduced vowel schwa. Webster's also uses schwa to represent the nonreduced vowel in words such as "cup." DECtalk expects that the stressed phoneme [ah] will be used in words like "cup."

In DECtalk, the reduced schwa vowel [ax] sometimes sounds better if replaced by the raised and fronted allophone [ix], particularly if the adjacent consonants are produced with the tongue tip. Trial and error can determine the optimal version of schwa in individual cases.

Word	Webster's	DECtalk
cup	\'kəp\ 	[k'ahp]
tuba	\'tuu-bə\ 	[t'uwbax]
kisses	\'kis-əs\ 	[k'ihsixs]

6. The final unstressed syllable in words such as "bottle," "button," and "butter" sounds better if the schwa-plus-consonant pronunciation suggested by Webster's is replaced by the syllabic consonant allophones.

Word	Webster's	DECtalk
bottle	\'bat-ə\ 	[b'aatel]
button	\'bət-ən\ 	[b'ahten]
butter	\'bət-ər\ 	[b'ahtrr]

E.2 AMERICAN HERITAGE DICTIONARY

The primary differences between American Heritage entries and DECtalk syntax is the placement of the stress mark after the syllable rather than before the vowel, as DECtalk requires.

Again, syllable boundary symbols should generally be omitted, and some secondary stresses may have to be omitted.

F TEXT TUNING EXAMPLE

This appendix contains the text used to demonstrate DECTalk at the 1984 IEEE International Conference on Acoustics, Speech, and Signal Processing. The text is presented twice, the first time as originally written, and the second time after phonemic and textual fixes were applied.

Original Version

[:np]

A California Shaggy Bear Tale
for Seven DECTalk Voices

By Dennis Klatt

[:nh] This story was used to demonstrate DECTalk at ICASSP-84, in May of 1984, at San Diego, California.

[:np] Once upon a time, there were three bears. They lived in the great forest, and tried to adjust to modern times.

[:nh] I'm papa bear. I love my family, but I love honey best.

[:nb] I'm mama bear. Being a mama bear is a drag.

[:nk] I'm baby bear and I have trouble relating to all of the demands of older bears.

[:np] One day, the three bears left their condominium to search for honey. While they were gone, a beautiful young lady snuck into the bedroom through an open window.

[:nw] My name is Whispering Wendy. My purpose in entering this building should be clear. I am planning to steal the family jewels.

[:np] Hot on her trail was the famous police detective, Frail Frank.

[:nf] Have you seen a lady carrying a laundry bag over her shoulder?

[:np] A woman kneeling with her left ear firmly placed against a large rock responded.

[:nu] No. No one passed this way. I've been listening for earthquakes all morning, but have only spotted three bears searching for honey.

Changed Version

[:np]

Add periods after the title and author.

A California Shaggy Bear Tale
for Seven DECTalk Voices.

By Dennis Klatt.

Make phonemic corrections.

[:nh] This story was used to demonstrate DECTalk at ['aykaesp] 84, in May of 1984, at [s'aendiy'eygow] California.

[:np] Once upon a time, there were three bears. They lived in the great forest and tried to adjust to modern times.

Add emphatic stress.

[:nh] I'm papa bear. I love my family, but I love [']honey best.

[:nb] I'm mama bear. Being a mama bear is a drag.

[:nk] I'm baby bear and I have trouble relating to all of the demands of older bears.

APPENDIX F

Begin a verb phrase.

[:np] One day, the three bears [] left their condominium to search for honey. While they were gone, a beautiful young lady snuck into the bedroom through an open window.

[:nw] My name is Whispering Wendy. My purpose in entering this building should be clear. I am planning to steal the family jewels.

Begin a new paragraph.

[:np] [+] Hot on her trail was the famous police detective, Frail Frank.

[:nf] Have you seen a lady carrying a laundry bag over her shoulder?

Add commas for phrasing.

[:np] A woman, kneeling with her left ear firmly placed against a large rock, responded.

Add pitch control and emphatic stress.

[:nu] [' '] No. No [/] one passed this [/ \] way. I've been listening for [' '] earthquakes all morning, but have only spotted three bears searching for honey.

BASIC PROGRAM EXAMPLE

G

```
1  !++
!
! TITLE: DT3SAMPLE.BAS
!
! VERSION: V1.0
!
! DATE: 3-OCT-1985
!
! FUNCTIONAL DESCRIPTION:
!
!
!       This is a sample program to control a DECTalk DTC03.
!
!       This program is written in a "compatible" subset of VAX BASIC.
!       It should run under most BASIC implementations with only
!       minor changes. For example, VAX BASIC no longer
!       requires the use of line numbers, and they have not
!       been used here except as necessary to the code.
!       Some of the "extended" features such as the SELECT
!       and DECLARE statements have been avoided to make this code
!       as transportable as possible.
!
!       This program has been tested on VMS V4.2, with VAX-BASIC V2.4.
!
! FORMAL PARAMETERS: None
!
! PRIVILEGES REQUIRED: None
!
! EXTERNAL ROUTINES CALLED: None
!
! MODIFICATION HISTORY:
!
! --
```

APPENDIX G

```

10      ON ERROR GO TO 19000

!
!      "Dynamic Storage, Function, and Constant Declarations"
!

DA$      = ESC+"[c"
DASTAT$  = ESC+"[?82;2;3c"
DSR$     = ESC+"[n"
DSRFIRST$ = ESC+"[?21n"
DSRAFTER$ = ESC+"[?20n"
DECSTR$  = ESC+"[!p"

! Define the diagnostics and their replies.
! See Chapter 5 of the DECTalk DTC03 Owner's Manual for
! the descriptions of these sequences.

DTPHONE$ = ESC+"P;60;"
DTEND$   = "z"+ESC+"\\"
DTANSWER$ = DTPHONE$+"10"+DTEND$
DTHANGUP$ = DTPHONE$+"11"+DTEND$
DTKEYPAD$ = DTPHONE$+"22"+DTEND$
DTNOKEY$  = DTPHONE$+"21"+DTEND$
DTTIMEOUT$ = DTPHONE$+"30;"
DTDIAL$   = DTPHONE$+"41z"
DTWINK$   = DTPHONE$+"50"+DTEND$
DTNOWINK$ = DTPHONE$+"51"+DTEND$

! Define the telephone management escape sequences.
! The sequences for timeout and dial a number both
! take another parameter, so define only the fixed
! parts of them here.

DTREPLY$ = ESC+"P;70;"
PHONHOOK$ = DTREPLY$+DTEND$
PHOFFHOOK$ = DTREPLY$+"1"+DTEND$
PHTIMEOUT$ = DTREPLY$+"2"+DTEND$
PHTOOLONG$ = DTREPLY$+"3"+DTEND$
PHWINK$    = DTREPLY$+"4"+DTEND$
PHNODIAL$ = DTREPLY$+"5"+DTEND$
PHBUSY$   = DTREPLY$+"6"+DTEND$
PHNOANS$  = DTREPLY$+"7"+DTEND$

! Define the answers that DECTalk will send back as
! replies to the phone commands.

DTMASK$   = ESC+"P;83;3072"+DTEND$
DTNOMASK$ = ESC+"P;83;0"+DTEND$

! Define the sequences to turn on and off keypad masking for
! the "*" and "#" characters.

DTSTOP$   = ESC+"P;10"+DTEND$
DTSYNC$   = ESC+"P;11"+DTEND$
DTSPEAK$  = ESC+"P;12;1"+DTEND$

! Define the speaking control sequences.

```

```

!
! BEGINNING OF MAINLINE CODE
!
1000 INPUT "DECTalk Device (e.g. TTA1: or TT2:)";DTDEVICE$
DTDEVICE$ = EDIT$(DTDEVICE$,-1%)
GO TO 1000 IF LEFT(DTDEVICE$,2%)<>"TT"
DTDEVICE$=DTDEVICE$+":" IF RIGHT(DTDEVICE$,LEN(DTDEVICE$))<>":"
DTDEVICE$ = DTDEVICE$+"DECTALK.OUT"
OPEN DTDEVICE$ AS FILE #1%

! Set DTDEVICE$ to the string required to "OPEN" the
! DECTalk device on a channel. RSX requires a full
! filespec, while VMS doesn't. The above string works
! for both operating systems. Open the DECTalk channel.

1010 UNTIL 0%
      WAIT 1%
      PURGEFLAG% = 1%
      GOSUB 10000
NEXT

! Purge the input buffer of any possible remaining "winks" or
! other garbage characters. Keep doing it until there
! is nothing in the buffer and BASIC returns a timeout error.
! Let the error handler send control back to the next line.
! Use a "flag" to tell the error handler where to resume.

1020 PURGEFLAG% = 0%
      WAIT 30%

      PRINT #1%, DECSTR$
      PRINT #1%, DTMASK$
      PRINT #1%, DSR$

! Now do a "soft" reset on the DECTalk,
! turn on the keypad mask feature,
! and request a Device Status Request to be sure the DT works.

      GOSUB 10000
      GO TO 32766 IF REPLY% <> DSR$

! Get the first response which is simply the DSR escape sequence.

      GOSUB 10000
      GO TO 32766 IF REPLY% <> DSRFIRST% AND REPLY% <> DSRAFTER%

! Now get the extended DSR reply response.
! This program doesn't care if there has been a power-failure
! since the user-defined dictionary isn't being used,
! so either response is OK.

      PRINT #1%, DA$
      GOSUB 10000
      GO TO 32766 IF REPLY% <> DASTAT$

! Send a Device Attribute Request to DECTalk. Exit if it
! doesn't answer with a "DECTALK3" reply.

```

APPENDIX G

```

!
!   MAIN MENU LOOP
!

1200  PRINT #1%, DTHANGUP$
      GOSUB 10000
      GO TO 32766 IF REPLY$ <> PHONHOOK$

      ! Hang up the phone, and look for the "on-hook" response.

      PRINT #1%, DTANSWER$
      GOSUB 10000
      GO TO 32766 IF REPLY$ <> PHONHOOK$
      PRINT "%ZDT3SAMPLE-I-WAITFORCALL, Waiting for call at: "; &
            TIME$(0%);" on ";DATE$(0%)

      ! Enable auto-answer of the phone, and look for an "on-hook"
      !   answer which means that DECTalk has processed the command.

1210  WAIT 600
      ANSFLAG% = 1%
      GOSUB 10000
      ANSFLAG% = 0%
      GO TO 32766 IF REPLY$ <> PHOFFHOOK$
      WAIT 30

      ! Reset the input timeout to 10 mins., and wait for DECTalk
      !   to answer the phone. The proper response is "off-hook."
      !   Then reset the timeout to 30 seconds.
      !   Use ANSFLAG% to tell the error handler to go back and
      !   re-run diagnostics if the phone isn't answered within 10 minutes.
      !   This will distinguish between a bad DECTalk and no
      !   activity on the line. The 10 minute timeout doesn't work
      !   on VMS since RMS only allocates a byte for the parameter.
      !   Therefore, BASIC always sets a timeout of 255 when it sees anything
      !   greater. This works differently on different operating
      !   systems.

1220  PRINT #1%, DTKEYPAD$
      GOSUB 10000
      GO TO 32766 IF REPLY$ <> PHOFFHOOK$

      ! Enable the telephone keypad in the new "Auto-stop" mode. In this
      !   mode the DECTalk3 does an "internal" stop/disable speaking
      !   whenever it sees a DTMF tone (key press).

```

```

1230 PRINT #1%, DTSPEAK$
      PRINT #1%, "[_<100>]Hello, this is DECTalk 3 speaking."
      PRINT #1%, "I am the latest member of the DECTalk family."
      PRINT #1%, "I am a multi line voice synthesizer that can "; &
              "control up to 8 telephone lines simultaneously."
      PRINT #1%, "Now I would like to demonstrate my ability to "; &
              "understand commands entered from a push button Phone."

      PRINT #1%, DTWINK$
      GOSUB 10000
      GO TO 32766 IF REPLY$ <> PHOFFHOOK$

      ! Enable the "Wink" detector to see if the user hangs up the phone.
      !   Go and get the response from DECTalk -- it should be "offhook"
      !   if the command is processed OK. Don't enable the wink
      !   detector until now because picking up the phone can
      !   look like a wink to the DECTalk.

1240 PRINT #1%, "Press any keys followed by the number sign key, and I "; &
      "will read back the number you have entered."
      PRINT #1%, "Press the star key to end this demonstration."

      ! "Auto-stop" mode does an implied "disable speaking" command,
      !   so the first thing to do is to re-enable it. Then speak.

      GOSUB 10000
      GO TO 1010 IF REPLY$ = PHWINK$ &

      ! Get the keys pressed and look for a "wink." If it's a "wink"
      !   then hang up the phone and start again.

      IF REPLY$ = "*" &
      THEN
          PRINT #1%, DTSPEAK$
          PRINT #1%, "Thank you for calling DECTalk 3."
          PRINT #1%, "Have a nice day."
          PRINT #1%, DTSYNC$
          GO TO 1200
      ELSE
          PRINT #1%, DTSPEAK$
          PRINT #1%, LEFT(REPLY$, LEN(REPLY$)-1X);"."
          PRINT #1%, DTKEYPAD$
          GOSUB 10000
          GO TO 32766 IF REPLY$ <> PHOFFHOOK$
          GO TO 1240
      END IF

      ! Speak a message and hang up the phone if "*" is pressed,
      !   otherwise read back the number and go get another.

```

APPENDIX G

```

!
!   DEFINE A FUNCTION TO GET INPUT FROM DECTALK
!
10000  REPLY$ = ""
10010  INPUT LINE #1%, SEQ$
        IF RIGHT(SEQ$,LEN(SEQ$)-1%)-CR+LF &
        THEN
            REPLY$ = REPLY$+LEFT(SEQ$,LEN(SEQ$)-2%)
        ELSE
            REPLY$ = REPLY$+SEQ$
            GO TO 10010
        END IF

        ! Since BASIC as implemented on VMS and RSX thinks that the
        !   <ESC> character is a terminator, keep looping
        !   around until we get the <CR> that DECTalk appends to output
        !   in "keypad mask" mode. BASIC also translates <CR> to <CR><LF>,
        !   so look for <CR><LF> and strip it off.

        RETURN

!
!   GLOBAL ERROR TRAP
!
19000  RESUME 19010 IF ERR <>15%
        RESUME 1010 IF ANSFLAG% = 1%
        RESUME 1020 IF PURGEFLAG% = 1%
        PRINT "%DT3SAMPLE-F-NORESPONSE, No response from DECTalk."
        RESUME 1200

        ! Got a timeout waiting for a response from DECTalk.
        !   If the timeout came in an expected place, then go
        !   back to the next line of code. Otherwise, print a message
        !   and hang up the phone.

19010  PRINT "%DT3SAMPLE-F-BASICERR, ";ERR,ERL,ERT$(ERR)
        GO TO 32767

        ! If it is any other error, then print it and exit.

32766  PRINT "%DT3SAMPLE-F-INVESCSEQ, "; &
        "Invalid escape sequence reply received"

        ! An invalid response to an escape sequence was received.
        !   Print an error message and exit.

32767  END

```

SERVICE AND DOCUMENTATION **H**

H.1 DIGITAL'S SERVICES

Your DECTalk DTC03 system comes with a warranty that gives you access to the best of Digital's resources, including our technical expertise, spare parts inventories, and worldwide service organization.

After warranty, Digital's support continues through a range of on-site and off-site service alternatives for as long as you own your Digital hardware. These services are designed to help you get the maximum performance from your system.

H.1.1 DECservice

DECservice is Digital's most comprehensive on-site service. It provides committed response time including a four-hour service response if your system is within 100 miles of a Digital service location. DECservice also provides continuous repairs until the problem is solved, a preventive maintenance program, installation of the latest engineering changes, and automatic escalation for complex problems.

DECservice lets you choose the hours of coverage you need to support your application, up to 24 hours a day, 7 days a week.

H.1.2 Basic Service

Basic service offers economical yet full service coverage. Your calls for service receive priority, second only to DECservice calls. You also receive preventive maintenance, installation of the latest engineering changes, and automatic escalation of complex problems.

Basic service is available during standard business hours, from 8:00 a.m. to 5:00 p.m., Monday through Friday.

H.1.3 Per Call Service

If your application does not demand comprehensive support, you can take advantage of one of Digital's per call programs.

Per call service is available on-site and off-site on a noncontractual basis. Service is available Monday through Friday during standard business hours, from 8:00 a.m. to 5:00 p.m.

For on-site per call service, you pay for the time and materials needed for each service call. Off-site per call service is available through mail-in board replacement and carry-in system repairs.

H.1.4 Carry-In Service

This is Digital's low-cost alternative to on-site support. You can carry your DECtalk into any of Digital's 150 Service Centers throughout the United States and pick up the repaired system within two days. Or, if you perform your own maintenance, you can carry in your faulty module and receive an immediate exchange.

Carry-in service is available through a one-year, fixed-cost agreement or on a per call basis that includes a flat rate for labor, plus the cost of all parts used in the repair. All carry-in service and parts come with a 90-day warranty.

H.1.5 DECmailer Service

DECmailer is a factory replacement service for Digital's customers who maintain their equipment to the module or subassembly level. It provides 5-day turnaround, free return shipping, 90-day warranty, 24-hour emergency service, monthly billing, and quarterly activity reports.

Whichever Digital service option you select, you will receive high-quality, reliable service delivered by one of the largest service organizations in the industry.

H.1.6 Digital Field Service Information Numbers

For more information on any of Digital's services, call the service information number in your area during normal business hours.

Australia	(02) 4125555
Austria	(222) 6776410
Belgium	(02) 2425095
Canada	(800) 267-5251
Denmark	(2) 889666
Finland	(0) 423511
France	(6) 0778292
Holland	(30) 640293
Ireland	(1) 308433
Italy	(02) 617961
Japan	(03) 989-7161
New Zealand	(09) 595-914
Norway	(2) 160290
Portugal	(1) 725402
Spain	(1) 7331900
Sweden	(8) 7338000
Switzerland	(01) 8169111
United Kingdom	(734) 868711
United States	(800) 554-3333
West Germany	(089) 95910

H.2 RELATED DOCUMENTS

The following DECtalk documents are available from Digital.

Title	Description
DECtalk DTC03 Owner's Manual (EK-DTC03-OM)	This manual provides complete information on DECtalk that may be required by a novice user or an application programmer. The manual gives an overview of DECtalk configuration, controls, self-tests, and description of DECtalk on-line operation. It also describes DECtalk phonemic codes, spoken text conventions, escape sequences, and programming methods for interfacing DECtalk with a host computer and telephone.
DECtalk DTC03 Programmer Reference Card (EK-DTC03-RC)	This card summarizes DECtalk phonemic codes, commands, and escape sequences.
DECtalk DTC03 Installation Manual (EK-DTC03-IN)	This guide explains how to configure, install, and check the DECtalk DTC03 system (rack enclosure and C5005 modules).
DECtalk DTC03 Pocket Service Guide (EK-DTC03-PS)	This guide explains how to troubleshoot and repair the DECtalk DTC03. This guide is for Digital's Field Service technicians.

H.3 ORDERING INFORMATION

You can order documents or supplies by telephone from 8:30 a.m. to 6:00 p.m. (EST) or by mail.

Continental USA and Puerto Rico

Call 1-(800)-258-1710 or write to:

Digital Equipment Corporation
P.O. Box CS2008
Nashua, NH 03061

New Hampshire, Alaska, Hawaii

Call 1-(603)-884-6660 or write to the above address.

Outside the USA and Puerto Rico

Write to:

Digital Equipment Corporation
Attn: Accessories and Supplies Business Manager
c/o Local Subsidiary or Digital-Approved Distributor

INDEX

- !, 63, 153
- ^, 63, 153
- *, 63, 153
- #, 63, 153
- >, 64
- <, 64

- [~], 84, 86
- [_], 86, 99
- ['], 77, 87, 88
- [`], 87, 89
- ["], 87, 90, 97
- [/], 87, 92, 129
- [\\], 87, 92, 129
- [/\], 87, 92
- [-], 84, 87, 92
- [*], 87, 93
- [#], 87, 93
- [)], 77, 87, 94
- [(], 87
- [,], 87, 95
- [.], 87, 96
- [?], 87, 96
- [!], 87, 97
- [+], 87, 97, 140
- [<>], 98-99
- [cp], 114, 116
- [dv _], 114, 118-134
- [n_], 114, 117-118
- [nb], 117

- [:nf], 117
- [:nh], 117
- [:nk], 117
- [:np], 117
- [:nr], 117
- [:nu], 117
- [:nv], 117, 134
- [:pp _], 114, 116
- [:ra _], 114, 115-116

- [ap], 120, 121, 128, 130-131
- [as], 120, 121, 128, 130
- [b4], 119, 121, 122, 124
- [b5], 119, 121, 122, 124
- [bf], 120, 121, 128
- [br], 119, 121, 125
- [f4], 119, 121, 122, 124
- [f5], 119, 121, 122, 124
- [g1], 120, 121, 132, 133-134
- [g2], 120, 121, 132, 133-134
- [g3], 120, 121, 132, 133-134
- [g4], 120, 121, 132, 133-134
- [gf], 120, 121, 132, 133
- [gh], 120, 121, 132, 133
- [gv], 120, 121, 132, 133
- [hr], 120, 121, 128, 129
- [hs], 119, 121, 122, 123
- [la], 119, 121, 125, 127
- [lo], 120, 121, 132
- [lx], 119, 121, 125

[nf], 119, 121, 125, 127
 [pr], 120, 121, 128, 130-131
 [qu], 120, 121, 128, 130
 [ri], 119, 121, 125, 126
 [save], 119, 134
 [sm], 119, 121, 125, 126
 [sr], 120, 121, 128, 130
 [sx], 119, 121, 122-123

A**Abbreviations**

in built-in dictionary, 168-169
 numeric, 161-167
 periods in, 167, 168
 processing, 160, 161, 167
 uppercase letters in, 168

Acronyms, 159**Advanced application, 140-141****Allophones**

consonant, 81, 85-86
 vowel, 80, 83-84

Alphabets, DECtalk and dictionary phonemic, 177-181**Alternate character sets**

designating, 38-41
 invoking, 42

Alternate pronunciation, 74-76, 94, 140, 173-176**Application development, 136-141****ASCII, 10, 18, 20, 21, 29-30, 31-35, 35-42****ASCII character sets, selecting, 29-30****ASCII code table, 32, 34****ASCII escape sequences, 18-19, 20-21****ASCII_G, 35, 36, 39****Average pitch, 128, 130-131****B****Backspace (BS), 22, 23, 32, 34 underlining, 23****Breathiness, 125****BS, 22, 23, 32, 34****Buffer**

overflow, 27
 size, 27

Built-in dictionary, 168-169**C****C0, 34-35, 43****C1, 34-35, 42, 43-44****C1 format setting parameters, 153****Call progress, 50, 57, 64****Call progress detection.**

See Call progress

Cardinal numbers, 163-164**Carriage return (CR), 22, 32, 34, 71, 87, 92, 134****Changing voice**

parameters, 118-134

Changing voices, 112-114, 117-118**Character sets, 29-30**

ASCII, 29-30, 32-35, 35-36

DEC Supplemental, 35, 37, 39

mapping, 30

selecting alternate, 35, 38-39

speaking, 29

U.K. national, 35, 38

Characters

backspace (BS), 23

dialing, 63-64

special, 22

Children's voices, 112, 117**Clause boundaries, 23, 95, 105, 106**

INDEX

- Clause terminator, 24, 104
- Code table
 - eight-bit, 34
 - seven-bit, 32
- Coding standards, 31
- Comma, 95
- Comma pause duration, 116
- Command, keypad mask, 70-72
- Command, telephone
 - management, 58-59
 - answer, 59, 61
 - hangup, 59, 61
 - keypad, 59, 62, 63
 - nokeypad, 59, 62
 - nop, 59
 - nowink, 59, 65
 - pulsedial, 59, 61, 63
 - stoppad, 59, 62
 - timeout, 59, 63
 - tonedial, 59, 61, 63
 - wink, 59, 65
- Command, test and status, 51-56
 - device status request (brief report), 53
 - device status request (extended report), 54-55
 - NVR control, 56
 - self-test, 52-53
 - soft terminal reset, 56
 - reset to initial state, 55
- Command, voice, 105-111
 - disable speaking, 106-107
 - enable speaking, 106-107
 - index query, 108-109
 - index reply, 108
 - index text, 107
 - input logging, 111
 - load dictionary, 110-111
 - speak phonemic text, 105
 - stop speaking, 105
 - synchronize, 27-28, 106
- Commands, 18
 - ending sequences, 19
 - invalid commands, 19
 - voice modification, 112-114
- Communication
 - modes, 45-46
 - parameters, 47, 154-157
- Communications
 - host-DECTalk, 2, 23-25, 26, 27-28
 - line-by-line, 70-72
 - telephone, 2, 57, 63-64
- Compound noun stress, 93
- Compound words, 93
- Configuration switches, 4, 154-157
- Conflicting commands, 135
- Conformance level, 49
- Connecting DECTalk to
 - a host computer, 2
 - a telephone service, 3, 57
- Consonant, 85
 - syllabic, 84
- Consonant phonemes, 79, 81
- Control characters, 22, 33
- Control codes
 - single-byte, 43
 - multibyte, 43-45
- Control commands
 - keypad mask, 70-72
 - load dictionary, 110-111
 - logging, 111
 - mode selection, 46-48
 - telephone management, 58-69
- Control sequence, 18, 43, 44
- Controlling DECTalk speech, 103
- Controls
 - LEDs, 5, 6
 - power switch, 3
 - pushbuttons, 5, 7
- Converting ASCII text to
 - phonemic code, 12-13
- Converting control commands, 13

Converting phonemic code, 13
 Converting text to speech, 10
 CR, 22, 32, 34
 CSI, 22, 34. *See also*
 Control sequence

D

DA primary, 50
 DA secondary, 50
 Dash, 47, 161, 163, 164
 Data loss, 27
 Data synchronization, 27-28, 106
 Dates, 161, 167
 DCS, 22, 34.
 See also Device control string
 Decimal value, 20, 21
 DECNVR, 51, 56
 DECSTR, 51, 52, 56
 DECTalk
 description, xiii, 2-7
 mode of operation, 9
 module, 3-7, 154-157
 setups, 26
 DECTST, 52
 Default voices, 113, 117-118, 144
 DEL, 32, 34
 Delete user dictionary, 52
 Design voice command
 parameters, 118-134
 assertiveness, 130
 average pitch, 130-131
 baseline fall, 128
 breathiness, 125
 cascade vocal tract
 gains, 133-134
 hat rise, 129
 head size, 123
 higher formants, 79, 124
 laryngealization, 127

 lax breathiness, 125
 loudness, 132
 minimum and maximum
 values, 119
 nopen fixed, 127
 pitch range, 130-131
 quickness, 130
 richness, 126
 save, 134
 sex, 122-123
 smoothness, 126
 sound source gains, 133
 stress rise, 130
 Device attribute requests, 50
 Device attributes, 50
 Device control string, 18, 43, 45
 Device identification, 50
 Device self-test, 52-53
 Device status error codes, 54-55
 Device status report, 53, 54
 Device testing, 8-9, 52-53, 157
 Dialing
 characters, 63-64, 153
 mode, 58, 63
 Dictionary manager, 11, 12
 Diphthong, 80
 Discarding host data, 27
 Documentation, 194
 DSR, 53
 DT_DICT, 110-111
 DT_INDEX, 107
 DT_INDEX_QUERY, 108-109
 DT_INDEX_REPLY, 108
 DT_LOG, 111
 DT_MASK, 70-72
 DT_MODE, 46-48
 DT_PHONE, 58-59
 DT_PHOTEXT, 105
 DT_SPEAK, 106-107
 DT_STOP, 105
 DT_SYNC, 106

INDEX

Duration and pitch, 98-99

Duration control, 98-99

E

Eight-bit mode, 30, 45-46

Emotions, 86, 98, 131

Emphasis, 77-78

Emphatic stress, 90

Empty parameter, 21

Enable autoanswer, 58, 61

Enable or disable
speaking, 106-107

Encoding tips, 139

Ending commands and data, 139

English, 74, 77-79, 103, 104

Enter phonemic text command, 105

ESC, 18-19, 22, 32, 34

Escape commands, 147-149

Escape sequence, 20-21, 43-44

ASCII characters, 18, 19, 20-21

decimal value, 21

format, 20

mnemonic, 21

parameters, 21

Exclamation point, 97

Exponents, 163

Extension, 50

F

Factory settings, 4, 154

Female/male parameter, 112-114,

117-118, 122-123

FF, 22, 32, 34

Firmware identification, 50

Flush pending text, 52

Formatter, number, 11, 12

Fractions, 161, 166

G

G0-G3 character sets, 38-41, 42

GL, 40, 41, 42

GR, 40, 42

Graphic characters, 33

H

Hang up telephone, 57, 61

Hardware identification, 50

Hat rise, 129

Head size, 123

Higher formants, 124

Host communications line

format, 51, 156

Host communications line

speed, 51, 156

Host-DECTalk interaction, 23-25

HOSTSYNC, 27

HT, 22, 32, 34

Hyphen, 47, 93, 161, 163

I

Index

defining an index, 107

last index seen query, 108-109

replying when an index is

spoken, 108

Index query command, 108-109

Index reply command, 108

Index text command, 107

Indexing text, 107

Input logging, 111

Intonation, 86, 96, 97

Invalid commands, 135

K

Keypad, 57, 58, 62
Keypad mask command, 70-72

L

Language spoken by DECTalk, 50
Laryngealization, 127
Lax breathiness, 125
Letters, multinational, 172
Letter-to-sound module, 11, 12
LF, 22, 32, 34
Lists, 95
Load dictionary command, 110-111
LOG_HOSTPH, 111
Long sentences, 94, 95
Loudness, 132
LS0, 39
LS1, 39
LS1R, 39
LS2, 39
LS2R, 39
LS3, 39
LS3R, 39

M

Male/female parameter, 112-114,
117-118, 122-123
Markers, stress and syntax, 86-97
Marking text, 107-108
Maximum/minimum
parameters, 118-120
Minus sign, 47, 163
Mnemonics, 20-21

Modes

eight-bit, 30, 45-46
operating, 9
phonemic, 105, 144
seven-bit, 30, 45-46
MODE_EUROPE, 47
MODE_MINUS, 47
MODE_SPELL, 47
MODE_SQUARE, 47
Modifying voices, 112-114, 118
Module, letter-to-sound, 11-12
Money, 161, 166
Monotone, 99, 118
Morpheme boundaries, 93
Multinational character set.
See DEC Supplemental
Multinational letters, 172

N

Names, 138
New paragraph, 97, 140
New voice command, 114,
117-118, 134
New voice design, 118
Nopen fixed, 127
Number formatter, 11, 12
Numbers
abbreviations, 161-166
ambiguous formats, 164
cardinal numbers, 163-164
commas in, 163
dates, 167
decimal fractions, 166
exponents, 163
fractions, 166
minus sign, 163

INDEX

- money, 166
- ordinal, 166
- plus sign, 163
- processing, 159-160, 161
- scientific notation, 163
- time of day, 167
- Numeric encoding, 138
- NVR, 56

- O**

- Operating mode, 9
- Ordering information, 195
- Ordinal numbers, 166
- Orthographic symbols, 86-87
- Overflow. *See* Buffer overflow
- Overload, 123, 124, 133

- P**

- P character, 63
- Packet-switched network, 72
- Parameters
 - design voice. *See* Design voice
 - command parameters
 - default communication, 154
 - default voice, 121
 - DT_MASK, 70
 - DT_MODE, 47
 - DT_PHONE, 59
 - module setup, 4, 155-156
 - self-test, 52-53
 - telephone command.
 - See* DT_PHONE
- Parameters in escape
 - sequences, 20-21
- Parenthetical remarks, 95

- Parser
 - sentence, 11, 12
 - word, 11, 12
- Part numbers, 138, 161-163
- Period, 96
- Period pause duration, 114, 116
- PH_ANSWER, 59, 61
 - two status reports, 61
- PH_HANGUP, 59, 61
- PH_KEYPAD, 59, 62, 63
- PH_NOKEYPAD, 59, 62
- PH_NOWINK, 59, 65
- Phone status reply codes, 60
- Phonemes
 - consonant, 79-81, 85-86
 - definition, 77, 78
 - stress markers, 86-87
 - syntax markers, 86-87
 - two-character system, 81, 138
 - vowel, 77, 79-81, 83-84
- Phonemic
 - alphabets, 177-179
 - commands, 103, 105
 - corrections, 74-76, 82, 140-143
 - mode, 105, 144
 - spelling, 103, 111, 142
 - theory, 77
 - transcription, 74
- Phonemics
 - DECtalk, 74
 - DECtalk and dictionary
 - correspondence, 177-181
- PH_PULSE_DIAL, 59, 61, 63
- Phrase structure module, 11, 13
- Phrasing, sentence, 86-87
- PH_STOPPAD, 59, 62
- PH_TIMEOUT, 59, 63
- PH_TONE_DIAL, 59, 61, 63
- PH_WINK, 59, 65

Pitch
 average pitch, 120, 130-131
 control, 98-99
 pitch range, 120, 130-131
 Plus sign, 163
 Polysyllabic words, 89
 Power-up, 3, 8
 Power-up status, 8, 51
 Prepositional phrases, 95
 Primary stress, 88
 Product identification, 50
 Programming
 considerations, 26, 136-137
 escape sequence format, 20-21
 Pronunciation
 alternate, 74-76, 77,
 140, 173-176
 errors, 74-76, 82, 142-143
 optimizing, 142-143
 Prosodic control, 98
 Pulse dialing, 57, 63-64
 PUP, 51, 52

Q

Question mark, 96
 Quickness, 130

R

R3_PH_BUSY, 60
 R3_PH_NOANSWER, 60
 R3_PH_NODIAL, 60
 R3_PH_OFFHOOK, 60
 R3_PH_ONHOOK, 60
 R3_PH_TIMEOUT, 60
 R3_PH_TOOLONG, 60
 R3_PH_WINK, 60

References

bibliographic, 102
 documentation, 194

Replies

DA, 50
 status, 53, 150-152

Reset, 51-52

to initial state, 51-52, 55

Restore operating features, 51

Return symbol, 22, 32, 34, 71,
 87, 92, 134

Rhythm, 86-87**Richness, 126****RIS. See Reset****Robot voice, 131****Rotary dial, 63****Rules for DECTalk**

sequences, 18-19, 20-21

S

S7C1T, 30, 46

S8C1T, 30, 46

Save parameter, 134

Scientific notation, 163

Second pronunciation, 77-78, 94,
 142, 173-176

Secondary stress, 89

Self-test

power-up, 8

routine, 8-9

Sentence parser, 11, 12

Sequences, 18-21
 ending, 19, 139

Service, 191-193

Settings

default, 51, 154

DIP switch, 4, 154-157

Seven-bit mode, 30, 45-46

INDEX

- Sex, 122-123
 - SI, 22, 32, 34
 - Sighing, 99
 - Silence
 - phoneme, 86, 99
 - symbol, 86, 99
 - Singing, 100-101
 - Smoothness, 126
 - SNA network, 72
 - SO, 22, 32, 34
 - Soft terminal reset, 56
 - SP, 22, 32, 34
 - Space symbol, 87, 92, 134
 - Speak command, 106-107
 - Speak phonemic text, 105
 - Speaker definitions, 118-134
 - parameters. *See* Design voice parameters
 - range, 119-120
 - Speaking rate, 114, 115-116
 - Speech control, 103
 - Speech synthesizer, 10, 11, 13
 - Speech timeout, 104
 - Speech tuning, 142-143
 - Spellout strategies, 170-171
 - SS2, 22, 39
 - SS3, 22, 39
 - ST, 22, 34. *See also*
 - String terminator
 - Standards, coding, 31
 - Status, power-up, 8, 51
 - Status report, 53-55
 - Status reporting, 53-55
 - Stop speaking, 105
 - Stress
 - emphatic, 90
 - primary, 88
 - secondary, 89
 - String terminator, 19
 - SUB, 22, 32, 34
 - Sustained sounds, 98-99
 - Switch-hook flash, 63
 - Syllabic consonants, 84
 - Syllable boundaries, 92
 - Synchronization, data, 27-28, 106
 - Synchronize command, 106
 - Syntactic function words, 91
 - Syntactic structure, 86-87
 - Syntactic symbols, 86-87
 - Synthesizer control
 - commands, 10, 13
 - Synthesizer gains, 133-134
- ## T
- T character, 63-64
 - Tab symbol, 87, 92, 134
 - Telephone
 - command parameters, 59
 - dial, 57, 63-64
 - keypad, 57, 62, 70-72
 - line, 3, 57
 - line interface, 57
 - management command, 58-59
 - replies, 60
 - status messages, 58, 60
 - Touch-Tone, 57, 63-64
 - Test, 8-9, 52-53
 - TEST_HCONTROL, 53
 - TEST_HDATA, 53
 - TEST_POWER, 53
 - TEST_SPEAK, 53
 - Text, 104
 - Text input, 2, 10
 - Text to speech, converting, 10
 - Time of day, 167
 - Timeout, telephone, 59, 63
 - Tone values, 101
 - Tones, 100-101
 - Touch-Tone dialing, 63-64
 - Two-character encoding, 138

U

- U.K. National character
 - set, 35, 38, 42
- Underline character, 23
- Unstressed syllables, 91
- Uppercase letters, 168, 170
- User dictionary, 12, 82-83,
110-111, 160
- User-definable
 - voice, 117-118, 118-134

V

- Verb phrase introducer, 94
- Vibrato, 100
- Voice command syntax, 134-135
- Voice design, 118
- Voice modification, 112-114
- Voice modification commands
 - comma pause duration, 114, 116
 - design voice, 114, 118
 - new voice, 114, 117-118
 - period pause duration, 114, 116
 - speaking rate, 114, 115-116
- Voice selection, 117-118
- Voices, DECTalk, 113, 117-118, 121
- Vowel phonemes, 80-81, 83
- VT, 22, 32, 34

W

- W character, 63-64
- Wink, 50, 57, 65
- Wink detection. See Wink
- Whitespace characters, 92
- Word boundaries, 92
- Word spellout, 170
- Words per minute, 115-116

X

- X character, 63-64
- XOFF, 26, 27-28
- XON, 26, 27-28

